

**OFF-
ROAD
LIVIN'**



can-am®

**2021 ACCESSORIES
FALL EDITION**

MAVERICK X3

LIMITS NEED
PUSHING. OUR
ACCESSORIES
WILL HELP.

**FIT &
COMPATIBILITY**



FOR US, INNOVATION IS A NO BRAINER.
ALL OUR ACCESSORIES WORK TOGETHER,
RIGHT OUT OF THE BOX. SO TAKE YOUR
PICK. THEN PICK SOME MORE.

can-am



STYLE & VISION



WE'VE UPPED THE ANTE ON ACCESSORIES. NOT JUST DESIGNED TO LOOK GOOD, BUT PERFORM RIGHT FOR REAL RIDERS. ALL KILLER, NO FILLER.

QUALITY & RELIABILITY



OUR CAN-AM ACCESSORIES ARE MADE RIGHT THE FIRST TIME. AND TO TOP IT OFF WE THREW IN A 1-YEAR WARRANTY. YOU'RE WELCOME. INSTALL THEM YOURSELF OR AT AN AUTHORIZED DEALER.

**BRP 1-YEAR
LIMITED WARRANTY**

For new Can-Am accessories, genuine parts, and co-branded products sold through BRP. Includes items installed by you or an authorized BRP dealer.

2021



**EXPERT
CHOICE**

LOOK FOR THIS LOGO THROUGHOUT THE CATALOGUE FOR EXPERT RECOMMENDATIONS ON INNOVATIVE, MUST-HAVE, ENTHUSIAST-READY PARTS AND ACCESSORIES THAT WILL HELP YOU CUSTOMIZE YOUR PERFECT OFF-ROAD MACHINE.

can-am[®]

MAVERICK

MAVERICK-X3

Built Inspirations	6
Roofs	12
Soft Cabs	16
Windshield & Mirrors	17
Doors & Rear Wind Protection	21
Skid Plates	24
Bumpers & Guards	25
Seat Accessories	32
LinQ: Easy on, easy off Cargo	33
Cargo & Racks	39
Lights	41
Audio & Communication Systems	47
Electrical & Electronic	50
Winches & Hitches	52
Performance	54
Covers & Add-Ons	60
Apache™ Track Systems	61
ProMount Plows	64
Tires & Rims	69

CAN-AMOFFROAD.COM

© 2020 Bombardier Recreational Products Inc. (BRP). All rights reserved. ®, TM and the BRP logo are trademarks of BRP or its affiliates. CARLISLE is a trademark of Carlisle Companies. CHAMUDE and HIPORA are registered trademarks of Kolon Industries, Inc. CLARINO is a trademark of Kuraray Co. Ltd. COOLMAX and THERMOLITE are registered trademarks of INVISTA for durable fabrics. DRIRELEASE is a registered trademark of Optimer Inc. FOX is a registered trademark of Fox Racing Canada. GARMIN and MONTANA are registered trademarks of Garmin Ltd. iPod is a registered trademark of Apple Inc. KOLPIN, GUN BOOT and IMPACT are registered trademarks of Kolpin Powersports Inc. KYB is a registered trademark of Kayaba. MicroSD is a registered trademark of SD Card Association. Mud Lite XTR and SS312 are trademarks of ITP Tires. NEXT G-1 VISTA is a trademark of Next Camo, LLC. NGK is a registered trademark of NGK Spark Plugs, Ltd. PRIMALOFT GOLD and PRIMALOFT BLACK are registered trademarks of Albany International Corp. TEFLON, TEFLON HT and KEVLAR are trademarks of E.I. DuPont de Nemours & Co. TWINAIR is a trademark of Twin Air USA. UNI is a trademark of UNIFILTER Inc. VELCRO is a registered trademark of Velcro Industries. WARN is a trademark of Warn Industries Inc. YUASA is a registered trademark of YUASA Batteries Inc. ZILLA and BIGHORN 2.0 are trademarks of Maxxis. SCOTT is a trademark of Scott Sports SA. The following trademarks are the property of their respective owners: BLUETOOTH, CREE, DURO, DWT, HELLA, ITP, KENDA, MOSSY OAK, RAM, SUR LAST, VISION, XPS and YOSHIMURA. DRAGONFIRE is a trademark of KRANSCO. Baja Designs is a registered trademark of Baja Designs Inc. S3 POWERSPORTS is a trademark of S3 Power Sports LLC. Some models depicted herein may include optional equipment. Prices, if shown, are based on Manufacturer Suggested Retail Prices. Dealers may sell for a different price. For Canada and US, taxes are not included. Depending on location, products are distributed by BRP US Inc., Bombardier Recreational Products Inc., BRP European Distribution SA, BRP Finland Oy, BRP Australia Pty Ltd. or BRP Brasil Motorsports LTDA. BRP reserves the right, at any time, to discontinue or change specifications, prices, designs, features, equipment without incurring obligation.

EXPERTLY-CHOSEN PACKAGES

ADD THE ACCESSORIES YOU WANT WITH 3 LEVELS OF UPGRADES: **STARTER**, **ADVANCED**, AND **PEAK**. OR MIX AND MATCH OPTIONS—IT'S YOUR RIDE.



YOU CAN FINANCE THE PURCHASE OF ACCESSORIES
with the purchase and financing of your Maverick X3. Ask your dealer for all the details.



DUNE



MUD



ADVENTURE



STARTER

Essential, recommended upgrades to immediately enhance any Can-Am vehicle.

ADVANCED

The best all-round, do-anything upgrades that have proven popular with experienced riders and new owners alike. Transform your Can-Am for the years of riding ahead.

PEAK

Limits are for other people: build your Can-Am Off-Road vehicle to overcome bigger obstacles & ride through larger adventures.

SEDUCED BY SAND?
CONQUER EVERY DUNE AND MAX-OUT
YOUR THRILLS WITH DEDICATED UPGRADES
FOR DUNE AND DESERT RIDING.



MAVERICK X3

DUNE

STARTER

715002909	Half Windshield	p. 19	\$294.99
715004732	Aluminum Half Doors	p. 22	\$734.99
715002961	Dune Front Bumper	p. 27	\$259.99
715002962	Dune Rear Bumper	p. 27	\$259.99
715004778	LinQ 8 Gal (30 L) Cooler Box	p. 37	\$374.99
715002882	Yoshimura Slip-on Exhaust	p. 57	\$1,054.99
			\$2,979.94

ADVANCED

715002881	LinQ Pivoting Rack	p. 39	\$469.99
715004276	Upper Door Storage Bags	p. 40	\$124.99
715003529	Light Support Bar	p. 43	\$214.99
710006821	Baja Designs XL Sport LED Lights	p. 42	\$439.99
710006818	Baja Designs Squadron Sport LED Lights	p. 41	\$1,779.99
710006819	10" Baja Designs OnX6 LED Light Bar	p. 42	\$469.99
			\$6,479.93

PEAK

715006315	Auxiliary Battery Installation Kit	p. 51	\$264.99
715004900	Audio Roof	p. 48	\$2,599.99
715002886	Lighted Whip Flag	p. 51	\$264.99
715002874	Electronic Device Holder	p. 49	\$149.99
			\$9,759.89

*Note that price does not include installation requirements and that part numbers may vary depending on vehicle model.

IF MUD'S WHAT YOU LOVE, YOU CAN PUT TOGETHER THE PERFECT VEHICLE WITH OUR MUD ACCESSORIES. GO ON... LIVE IT UP DOWN IN THE DIRT.



MAVERICK X3 X mr

MUD

STARTER

715005599	Snorkel Pre-Filter	p. 63	\$99.99
715004291	Tinted Half Windshield	p. 19	\$314.99
715004870	S3 Mud Rear Pull Plate	p. 31	\$124.99
715004007	39" (99 cm) Double Stacked LED Light Bar (270W)	p. 44	\$744.99
715003529	Light Support Bar	p. 43	\$214.99
715002886	Lighted Whip Flag	p. 51	\$264.99
			\$1,764.94

ADVANCED

715004867	S3 Front Bumper	p. 31	\$444.99
715004869	S3 Rear Bumper	p. 31	\$609.99
715006416	Can-Am HD 4500 Winch	p. 52	\$319.99
715004778	LinQ 8 Gal (30 L) Cooler Box	p. 37	\$374.99
715004937	Radiator Relocator	p. 59	\$1,159.99
			\$4,674.89

PEAK

715002874	Electronic Device Holder	p. 49	\$149.99
715004900	Audio Roof	p. 48	\$2,599.99
715005183	In-Line Triple Yoshimura Slip-On Exhaust	p. 57	\$1,259.99
			\$8,684.86

*Note that price does not include installation requirements and that part numbers may vary depending on vehicle model.

EXPLORE THE LIMITS OF YOUR SENSE OF ADVENTURE WITH ACCESSORIES DESIGNED TO BRING OUT THE EXPLORER IN YOU.



MAVERICK X3 MAX X ds TURBO RR

ADVENTURE

STARTER

715003868	Adventure Roof Rack	p. 39	\$599.99
715005277	ProVent Windshield	p. 19	\$809.99
715005315	Side Mirrors	p. 20	\$259.99
715006701	Rear Wind screen	p. 23	\$104.99
715002881	LinQ Pivoting Rack	p. 39	\$469.99
			\$2,244.95

ADVANCED

715004732	Aluminum Half Doors – Front	p. 22	\$734.99
715004753	Aluminum Half Doors – Rear	p. 22	\$734.99
715004698	LinQ 8 Gal (30 L) Cooler Box	p. 37	\$374.99
715002923	LinQ Premium Storage Bag by Ogio	p. 37	\$409.99
715006693	Front Window Nets	p. 23	\$164.99
715006700	Rear Window Nets	p. 23	\$164.99
715002875	LinQ Dry Bag	p. 35	\$199.99
			\$5,029.88

PEAK

715004007	39" (99 cm) Double Stacked LED Light Bar (270W)	p. 44	\$744.99
715005510	Lonestar Racing Front Bumper – Silver	p. 29	\$404.99
715005512	Lonestar Racing Rear Bumper – Silver	p. 29	\$434.99
715006709	Can-Am Audio Roof – MAX	p. 48	\$3,749.99
715007227	Can-Am Amplifier kit	p. 48	\$499.99
			\$10,864.83

*Note that price does not include installation requirements and that part numbers may vary depending on vehicle model.

YOU'VE SEEN THE OPTIONS... NOW
BUILD YOUR OWN



Create the ride you always dreamed of using
our outstanding range of quality accessories.

Customize your own Can-Am Off-Road at
CAN-AM.BRP.COM/OFF-ROAD

ROOFS

MADE WITH HIGH-QUALITY MATERIALS DESIGNED IN CONCERT WITH YOUR CAN-AM, OUR ROOFS CREATE A STRONG, LIGHT, RESILIENT BARRIER FROM THE ELEMENTS.



BUILT FOR YOUR VEHICLE

Engineered with the same design, fit, finish, and built-to-last quality found across our lineup.



↔ MAKE IT YOURS

Roof options are the perfect platform for numerous Can-Am accessories that truly transform your Maverick X3.



100% INTEGRATED

From the power system to speaker mounting, fit and finish, these audio systems were born to rock your Maverick X3.

EXPERT CHOICE

SPORT ROOF

- Impact-resistant injected polypropylene.
- Excellent protection from the elements.
- Provides excellent downhill visibility.
- Windshield compatible.
- Standard on X rs model.

Maverick X3

- Easy, tool-less installation and removal with quick-release ¼ turn fasteners and Velcro straps.

715002902

\$389.99



INSTALLATION



Maverick X3 MAX

- Easy installation.

715003750

\$734.99



EXPERT CHOICE

PROVENT ROOF MODULE KIT

- Provides fresh air into the cab area.
- Optimal performance with full cab enclosure.
- 4 vents provide infinite adjustment of air flow for driver and passenger.
- Filter and pre-filter to limit dust intrusion.
- Easy cleaning of filter and pre-filter.
- Patent-pending water management system to keep water out of cabin while maintaining air flow.
- Not compatible with roof mounted LED bars, roof racks or roof liners.
- Outer plug closes air intake completely for winter or heavy weather.
- Requires ProVent Roof Module Adapter Kit (715006199 / 715006371 for MAX), no additional requirement for Can-Am Aluminium Roof.

Maverick X3.

Maverick X3 MAX

715005279

\$204.99

INSTALLATION



PROVENT ROOF MODULE ADAPTER KIT FOR SPORT ROOF

(Not illustrated)

- Adapter for fitting ProVent Roof Module Kit onto Maverick X3 Sport Roof.
- Includes roof adapter and hardware.
- Requires ProVent Roof Module Kit (715005279).

Maverick X3

715006199

\$80.99



Maverick X3 MAX

715006371

\$80.99

ALUMINUM ROOF

- Formed aluminum roof 0.09" (2.3 mm) thick.
- Durable and lightweight.
- Sporty look.
- Windshield compatible.
- Easy and tool-less installation.

Maverick X3

715004224 • Black 
\$599.99

715002900 • Silver 
\$524.99



BIMINI ROOF WITH SUN VISOR

- Heavy-duty canvas made of UV-resistant solution-dyed polyester.
- Innovative soft top comes with a hard visor that allows for storage of rolled-up soft top.
- Easy, tool-less installation and removal with quick-release ¼ turn fasteners and Velcro straps.

Maverick X3

715002901 
\$314.99

Maverick X3 MAX

715003749 
\$344.99



TINTED SUN VISOR

- Tinted polycarbonate construction.
- Extra protection for driver and passenger from the sun.
- Not compatible with Aluminum Roof and Full Windshields.

Maverick X3, Maverick X3 MAX

715007098
\$244.99





AT LONESTAR RACING, IT'S ALL RACE-ENGINEERED, COMPETITION-PROVEN ACCESSORIES.

GIVE YOUR BEAST MORE BACKBONE



LONESTAR RACING ALUMINUM ROOF

- 0.083" (2.1 mm) thick aluminum roof.
- Durable and lightweight.
- Enhances the vehicle's racing appearance thanks to an authentic sporty look combined with unique graphics.
- Offers you protection from the elements with a personalized touch.
- Lower profile than other roofs.
- Compatible with Lonestar Racing Light Bar Racks.
- Not compatible LinQ Pivoting Rack, Light Support Bar and with Full Windshields.
- "Lonestar Racing for Can-Am" branded.

Includes middle intrusion bars for installation



Hyper Silver / Black Graphics

Maverick X3
produced after January 1, 2017

■ 715005508 • Hyper Silver 

■ 715005507 • Black 

Maverick X3 MAX

■ 715005516 • Hyper Silver
\$1,464.99

■ 715005515 • Black
\$1,409.99

Can-Am Red

Maverick X3
produced after January 1, 2017

■ 715004436 • Can-Am Red 

\$784.99

Maverick X3 MAX

■ 715004341 • Can-Am Red
\$1,464.99

SOFT CABS



1. BIMINI ROOF WITH SUN VISOR
2. UPPER SOFT DOOR PANELS
3. SOFT REAR WINDOW
4. FULL WINDSHIELD — HARDCOATED
5. LOWER DOOR PANELS

HARSH ELEMENTS DON'T STAND A CHANCE!

SOFT CAB ENCLOSURE

- Protection for rider and passenger from the elements.
- For added cabin comfort, complete your cab enclosure with Cab Seal Kit.

Maverick X3

Includes:

- Bimini Roof with Sun Visor
- Full Windshield — Hardcoated
- Upper Soft Door Panels
- Front Lower Door Panels
- Soft Rear Window

715003754

\$1,994.99

Maverick X3 MAX

Includes:

- Bimini Roof with Sun Visor
- Full Windshield — Hardcoated
- Upper Soft Door Panels
- Front Lower Door Panels
- Soft Rear Window

715003755

\$2,819.99

CAB SEAL KIT

(Not illustrated)

- Prevents dirt, dust and wind infiltration in the cab area.
- Improves cabin comfort for driver and passenger.
- Recommended with Soft Cab Enclosures.

Maverick X3

715004433

\$40.99

Maverick X3 MAX

715004434

\$26.99

DESIGN
YOUR OWN
CAB.

PICK THE ACCESSORIES OF
YOUR CHOICE AND BUILD OR
COMPLETE YOUR OWN CAB.



100% modular components designed to work together:

ROOFS [P.12](#)
WINDSHIELDS [P.17](#)

DOORS [P.21](#)
REAR WINDOWS [P.23](#)

WINDSHIELD

DEVELOPED TOGETHER WITH YOUR MAVERICK X3 TO ENSURE THEY FIT, LOOK AND PERFORM AS THEY SHOULD.



QUANTUM COATING
Our Full Windshield — Hardcoated is made of high-impact-resistant Quantum hardcoated polycarbonate to ensure a long life.



POWERFLIP WINDSHIELD

Allows you to quickly adapt to changing conditions by adjusting the windshield as you go.



100% INTEGRATED

Your Can-Am's standard profiled cage allows our accessories to install easily, with a perfect fit.



EXPERT CHOICE

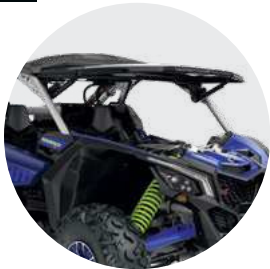

FULLY OPENED

for optimal visibility and ventilation



INFINITE POSSIBILITIES IN BETWEEN

depending on protection, visibility and air flow preferences

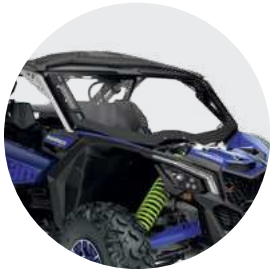

FULLY CLOSED

for maximum protection from the elements

TOTAL AIR FLOW CONTROL

Industry's first powered flip windshield



POWERFLIP WINDSHIELD

- The PowerFlip Windshield is equipped with electric cylinders that allow the rider to adjust the windshield opening at the touch of a button.
- Windshield is made of hardcoated polycarbonate with a rubber seal contour and a tinted top section.
- Allows you to quickly adapt to changing conditions by adjusting the windshield as you go.
- Can be fully opened for optimal visibility and ventilation, fully closed for maximum protection from the elements, and in between, you have an infinite number of opening possibilities depending on protection, visibility and air flow preferences.
- Compatible with Can-Am roofs.

Maverick X3, Maverick X3 MAX

715007097
\$1,259.99

NEW WINDSHIELD WIPER FOR POWERFLIP WINDSHIELD

- An ideal way to keep your windshield clear in rain or while riding through mud and water.
- Wiper from the top allowing windshield pivoting. Includes single-speed wiper and washer-fluid dispenser.
- Wiper mechanism and washer-fluid dispenser perfectly concealed within the vehicle.
- Must be installed with the PowerFlip Windshield (sold separately).

Maverick X3, Maverick X3 MAX

715006310
\$699.99

INSTALLATION 





GLASS WINDSHIELD

- Curved and laminated glass full windshield.
- Seals firmly against the cage and protects rider and passenger from the elements.
- Provides the best optical clarity and abrasion resistance.
- Must be used with Windshield Wiper & Washer Kit to maintain clear visibility during severe riding conditions, such as mud riding.
- Usage of a rear wind protection is recommended.

Maverick X3, Maverick X3 MAX

715003281 
\$994.99

EXPERT CHOICE

PROVENT WINDSHIELD

- High-impact-resistant Quantum hardcoated polycarbonate full windshield.
- Controllable vents to manage air flow.
- Optimal performance with full cab enclosure.
- Channels air into the cabin, defogs windshield, fully closes to eliminate air flow.
- One upper vent and one lower vent with pre-filters.
- Formed polycarbonate construction for enhanced rigidity.
- Provides excellent optical clarity and better abrasion resistance.
- Protects driver and passenger from the elements.
- Quick and easy tool-less installation or removal.
- Not compatible with wiper kits and and Wet Sounds Stealth 6 Ultra HD Can-Am Edition Sound Bar.

Maverick X3, Maverick X3 MAX

715005277 
\$809.99

INSTALLATION 



Upper vent channels air into the cabin

Lower vents defog windshield



GLASS WINDSHIELD WITH WIPER & WASHER KIT

- Complete kit that includes the curved and laminated glass windshield with the single-speed wiper and washer fluid dispenser.
- Seals firmly against the cage and protects rider and passenger from the elements.
- An ideal way to keep your windshield clear in rain, or while riding through mud and water.
- Must be used with rear wind protection.

Maverick X3, Maverick X3 MAX

715003283 
\$1,464.99



FULL WINDSHIELD

- High-impact-resistant durable polycarbonate full windshield.
- Formed polycarbonate construction for enhanced rigidity.
- Formulated to be non-yellowing, non-crazing, non-cracking with excellent UV resistance and optical clarity.
- Protects driver and passenger from the elements.
- Quick and easy tool-less installation or removal.
- Must be used with rear wind protection.

Maverick X3, Maverick X3 MAX

715002907 
\$419.99



FULL WINDSHIELD - HARDCOATED

- High-impact-resistant Quantum hardcoated polycarbonate full windshield.
- Formed polycarbonate construction for enhanced rigidity.
- Provides excellent optical clarity and better abrasion resistance.
- Protects driver and passenger from the elements.
- Quick and easy tool-less installation or removal.
- Must be used with rear wind protection.
- Can be used with the Windshield Wiper and Washer Kit (715004762).

Maverick X3, Maverick X3 MAX

715004417 
\$629.99

WINDSHIELD WIPER & WASHER KIT

- An ideal way to keep your windshield clear in rain, or while riding through mud and water.
- Includes single-speed wiper and washer fluid dispenser.
- Wiper mechanism and washer fluid dispenser perfectly concealed within the vehicle.
- Must be used with Full Windshield Hardcoated (715004417).

Maverick X3, Maverick X3 MAX

Fit with Full Windshield Hardcoated (715004417)

715004762 
\$584.99

Maverick X3, Maverick X3 MAX
Fit with Glass Windshield (715003281)

715003282 
\$584.99



HALF WINDSHIELD

- High-impact-resistant durable polycarbonate half windshield.
- Formed polycarbonate construction for enhanced rigidity.
- Formulated to be non-yellowing, non-crazing, non-cracking with excellent UV resistance and optical clarity.



CLEAR WINDSHIELD

715002909 
\$294.99

- Protects driver and passenger from the elements.
- Features reverse angle lip to deflect air flow.
- Quick and easy tool-less installation or removal.

Maverick X3, Maverick X3 MAX



TINTED WINDSHIELD

715004291 
\$314.99

EXPERT CHOICE



REAR MIRROR & CAMERA MONITOR

- Fully waterproof rearview camera and monitor kit.
- Multiple camera feeds can be seen with the rear view camera, to see what you need.
- Unit replaces stock rearview mirror (screen is integrated in the unit's replacement rearview mirror).
- Camera uses infrared light for night vision capabilities.

Maverick X3, Maverick X3 MAX

715004905 - Black 

\$434.99



SIDE MIRRORS

- Rugged cast aluminum mount with black nylon cover.
- Multi-position adjustable ball-joint mounted mirrors.
- Convex optics for a wide viewing angle.
- Spring-loaded pivots let mirrors fold back completely.
- Door mounted.
- Compatible with Upper Soft Door Panels.
- Sold in pairs.

Maverick X3, Maverick X3 MAX

715004236 - For stock quarter doors 

\$259.99

715005315 - For aluminum doors 

\$259.99



RACING SIDE MIRRORS

- Race-inspired design features rugged black nylon % construction with coated cast-aluminum mount.
- Dual adjustment provides optimal field of view (FOV).
- Multi-position adjustable ball-joint mounted mirrors.
- Flat optics deliver improved distance perception.
- Spring-loaded pivots let mirrors fold back completely.
- Not compatible with Lonestar Racing Light Racks and Upper Soft Door Panels.
- Sold in pairs.

Maverick X3, Maverick X3 MAX

715002898

\$209.99



DOORS

DUNES, DESERT, MUD & TRAIL—COMFORT, PROTECTION
& GREAT LOOKS WHEREVER YOU ROAM.



PERFECT-FIT

Choose ultimate fit and rigidity that sits firmly against the cage for complete rider protection from the elements.



ALUMINUM HALF DOORS

Perfect full door coverage in strong, lightweight aluminum — includes Deluxe Door Handles.



DELUXE DOOR HANDLES

Sturdy inside-outside handles replace door pulls for even faster cockpit entry and exit.

EXPERT CHOICE

ALUMINUM HALF DOORS

- Lightweight half doors made of formed 5/64" (2 mm) thick aluminum.
- Textured black powder coat finish for superior scratch resistance.
- Engineered for maximum rigidity and durability.
- Designed for a perfect fit and seamless integration with the vehicle's lines.
- Contoured with a thick seal for better protection from the elements.
- Easy installation using the standard door frame.
- Include the easy-to-operate Deluxe Door Handles.
- Compatible with the Upper Soft Door Panels, the Window Nets and Upper Door Storage Bags.
- Not compatible with the Lower Door Panel Storage Bags.
- Sold in pairs.

Maverick X3, Maverick X3 MAX

715004732 • Front
\$734.99



INSTALLATION ▶

Maverick X3 MAX

715004753 • Rear
\$734.99



INSTALLATION ▶



DELUXE DOOR HANDLES

- Convert the standard door straps into easy-to-access door handles.
- Include inside and outside handles for each door.
- Greatly facilitate door opening.
- Standard on accessory Aluminum Half Doors.
- Sold in pairs.

Maverick X3, Maverick X3 MAX

715004758 • Front
\$174.99



Maverick X3 MAX

715004860 • Rear
\$174.99

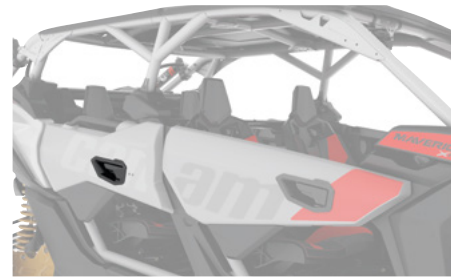

STAY LOCKED AND LOADED WITH DELUXE EXTERIOR DOOR HANDLES.

LOWER DOOR PANELS

- Robust injection-molded polypropylene construction designed to match vehicle.
- Extend stock doors at bottom to protect and seal cab area.
- A great-looking add-on.
- Easy and quick installation.
- Sold in pairs.
- Rear Lower Door Panels sold separately.

Maverick X3, Maverick X3 MAX

715002903 • Front
\$359.99



715003751 • Rear
\$364.99

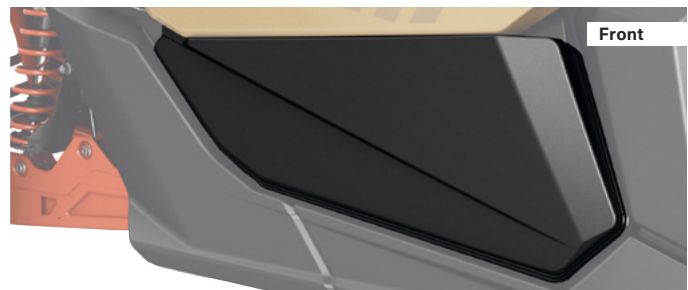

Front



Rear

EFFECTIVELY REDUCE
WIND BACKDRAFTS
& DEBRIS INTO YOUR CAB.



WINDOW NETS

- Window mesh screen for added protection from wind.
- Can be easily lowered in seconds
- Sold in pairs.

Maverick X3

715006693 • Front
\$164.99

Maverick X3 MAX

715004694 • Front \$159.99



715006700 • Rear
\$164.99



UPPER SOFT DOOR PANELS

- Weather-resistant panels reinforced with aluminum frame offer good protection from the elements.
- Extend stock quarter doors at the top.
- Made of heavy-duty UV-resistant solution-dyed polyester canvas for excellent resistance to tear and abrasion.
- Zip-down windows made of laminated polished vinyl material for added ventilation.
- To be combined with the Lower Door Panels to obtain complete door kits for your vehicle.
- Not compatible with Racing Side Mirrors.

Maverick X3 (2 doors)

715007118
\$734.99

Maverick X3 MAX (4 doors)

715003753 \$1,409.99



REAR WIND SCREEN

- Full rear mesh screen reduces windshield backdraft for added cabin comfort.
- Installs quick and easily on roll cage.
- Large white Can-Am logo on black mesh.

Maverick X3, Maverick X3 MAX (except X mr models)

715006701
\$104.99



REAR POLYCARBONATE WINDOW

- High-impact-resistant polycarbonate window.
- Blocks windshield backdraft or dust and rain from entering for added cabin comfort.
- Quick and easy tool-less installation.
- Ready for MTX Audio System Rear Speakers.

Maverick X3, Maverick X3 MAX (except X mr models)

715006387
\$299.99



SOFT REAR WINDOW

- Clear, flexible window made from transparent vinyl.
- Resists cold-cracking to -4 °F (-20 °C).
- Ideal for preventing backdraft of dust or rain in harsh environments.
- Quick tool-less installation.

Maverick X3, Maverick X3 MAX (except X mr models)

715006702
\$104.99



HMWPE SKID PLATES

Our Plastic Plates glide smoothly and silently over obstacles, offering great protection in rough terrain. Made of abrasion-resistant thermoformed 3/8" (10 mm) thick High Molecular Weight Polyethylene (HMWPE).

- ✓ Lighter than aluminum
- ✓ Superior stress crack resistance
- ✓ High-impact strength

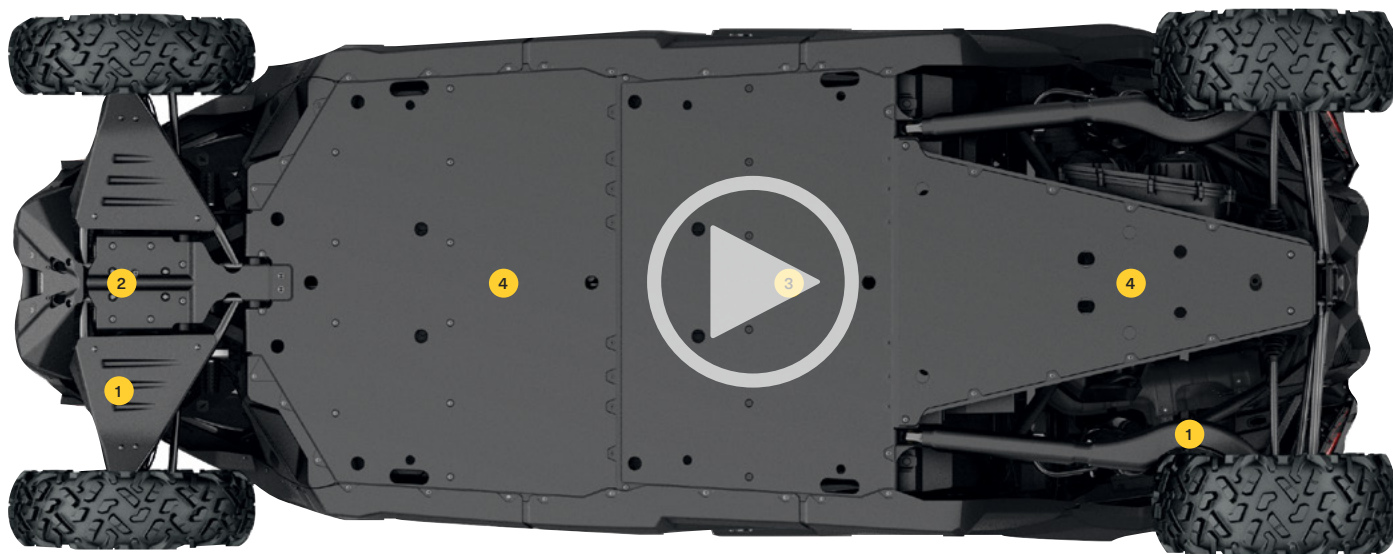

715003747

HMWPE SKID PLATES ARE STANDARD ON MAVERICK X3 X rc MODELS.		MAVERICK X3 64" MODELS	MAVERICK X3 MAX 64" MODELS	MAVERICK X3, MAVERICK X3 MAX 72" MODELS (EXCEPT BASE MODELS)	MAVERICK X3 BASE 72" MODELS	MAVERICK X3 MAX BASE 72" MODELS
FULL PROTECTION KIT						
HMWPE Skid Plate Protection Kit	715003713 \$819.97	715003747 \$1,034.96	715003718 \$384.98	715006767 \$839.97	715006769 \$1,054.96	
INDIVIDUAL HMWPE SKID PLATES						
1	HMWPE Front A-Arm and Trailing Arm Protectors	715002905 \$264.99	715002905 \$264.99	715003552 \$284.99	715003552 \$284.99	715003552 \$284.99
2	HMWPE Front Skid Plate	715003933 \$99.99	715003933 \$99.99	715003933 \$99.99	715003933 \$99.99	715003933 \$99.99
3	HMWPE Central Skid Plate	—	715003731 \$214.99	Standard on these models	—	715003731 \$214.99
4	HMWPE Underbelly Plate	715004904 \$454.99	715004904 \$454.99	Standard on these models	715004904 \$454.99	715004904 \$454.99

BUMPERS

STRENGTH AND CHARACTER TO ENDURE IT ALL.
OUR BUMPERS ARE READY FOR IT.



BETTER CORROSION PROTECTION
Can-Am bumpers are E-Coated for supreme corrosion protection inside and out.



100% INTEGRATED
Seamlessly fit the style and finish of your Maverick X3.



 **LIGHT READY**
Fully integrated light mounting plate.
Multiple light installation options.

PROTECT & PUSH YOUR RIDE WITH CONFIDENCE THROUGH THE WORST.





EXPERT CHOICE

FRONT PRE-RUNNER BUMPER

- Made of 1.5" (3.8 cm) diameter steel tubing with a 1/8" (3 mm) aluminum plate for extra durability.
- Inside and outside anti-corrosion coating with durable powder coat finish.
- Added heavy-duty protection in extreme driving conditions.
- Integrated winch mounting plate and mount points for lights.

Maverick X3, Maverick X3 MAX

■ 715002878 • Black  \$304.99

■ 715003433 • Can-Am Red  \$364.99



REAR PRE-RUNNER BUMPER

- Extra-durable 1.5" (3.8 cm) diameter steel tubing with a 1/8" (3 mm) aluminum plate.
- Inside and outside anti-corrosion coating with durable powder coat finish.
- Protects vehicle bodywork and exhaust system.
- Rear Receiver Hitch compatible.
- Required for installation of the Rear Cage Extension.

Maverick X3, Maverick X3 MAX

■ 715002880 • Black  \$304.99

■ 715003436 • Can-Am Red  \$364.99



FRONT INTRUSION BAR

- Matches vehicle styling.
- Inside and outside anti-corrosion coating with durable powder coat finish steel intrusion bar.
- Tube design reduces obstructed lines of sight and blind spots for better visibility.
- Not compatible with windshields and Lonestar Racing Aluminum Roof.

Maverick X3, Maverick X3 MAX

■ 715002889 • Black
\$344.99



■ 715003435 • Can-Am Red
\$394.99



REAR CAGE EXTENSION

- Durable 1.5" (3.8 cm) diameter steel tubing.
- Inside and outside anti-corrosion coating with durable powder coat finish.
- Allows holding a spare tire in place (wheel not included).
- Custom tie-down strap for fast tire installation or removal.
- Rear Pre-Runner Bumper required for installation.
- Not compatible with LinQ Pivoting Rack, cargo boxes (except LinQ 20 Gal (73 L) Deluxe Modular Bag) and Lonestar Racing roofs.

**Maverick X3 (except X mr models),
Maverick X3 MAX**

■ 715002890 • Black
\$259.99



■ 715003434 • Can-Am Red
\$314.99



DUNE FRONT BUMPER

- Made of 1.5" (3.8 cm) diameter aluminum tubing with a 1/8" (3 mm) aluminum plate.
- Inside and outside anti-corrosion coating with durable powder coat finish.
- Provides added protection without sacrificing the agility and performance advantages of a lighter weight design.
- Features a more pronounced attack angle and integrated mounting points for lights.
- Not winch compatible.

Maverick X3, Maverick X3 MAX

■ 715002961 • Black
\$259.99



■ 715003432 • Can-Am Red
\$304.99



DUNE REAR BUMPER

- Made of 1.5" (3.8 cm) diameter aluminum tubing with a 1/8" (3 mm) aluminum plate.
- Inside and outside anti-corrosion coating with durable powder coat finish.
- Provides added protection without sacrificing the agility and performance advantages of a lighter weight design.
- Protects vehicle bodywork and exhaust system.
- Rear hitch compatible.
- Not compatible with Rear Cage Extension and Lonestar Racing Spare Tire Holder.

Maverick X3, Maverick X3 MAX

■ 715002962 • Black
\$259.99



■ 715003437 • Can-Am Red
\$304.99





X rc / X mr FRONT BUMPER

- Made of 1.5" (3.8 cm) diameter steel tubing with a 1/8" (3 mm) aluminum plate.
- Inside and outside anti-corrosion coating with durable powder coat finish on steel tubing.
- Offers all the essential features required for technical driving: Low front-end protection, support base for winch installation and integrated tow hook.
- Standard on Maverick X3 X rc and X mr models.
- Not compatible with winches with steel cable.

Maverick X3, Maverick X3 MAX

- | | |
|---|---|
|  715004741 • Sunburst Yellow |  715004788 • Black |
|  715004742 • Octane Blue | \$404.99 |
|  715004789 • Can-Am Red | |
- \$464.99**





ROCK SLIDERS

- Made of heavy-duty 1.5" (3.8 cm) diameter steel tubing.
- Inside and outside anti-corrosion coating with durable powder coat finish.
- Protect vehicle's sides and undercarriage against large obstacles.
- Support plate adds rigidity and style.
- Sold in pairs.

Maverick X3 (except X rc)

-  715002963 • Black 
- \$259.99**

-  715003438 • Can-Am Red 
- \$314.99**

Maverick X3 MAX

-  715003730 • Black 
- \$384.99**

-  715003888 • Can-Am Red 
- \$434.99**



X rc UHMWPE ROCK SLIDERS

- Robust 1/4" (6 mm) UHMWPE construction.
- Include lower body panels and brackets for installation.
- Protect vehicle's sides and undercarriage against large obstacles.
- Lodge tight up against vehicle body for better clearance from obstacles.
- Slide smoothly over obstacles.
- Sold in pairs.

Maverick X3

- 715004730 
- \$629.99**



FENDER FLARES

- Extended fender flares made from injection-molded polypropylene.
- Keep mud and debris out of vehicle.
- Designed for quick and easy installation.
- Include front and rear extensions and mounting hardware.

Maverick X3, Maverick X3 MAX

- 715002973 
- \$314.99**





RACING DESIGN FOR PEAK PERFORMANCE.

Race-engineered with a reputation for toughness and style.



LONESTAR RACING FRONT BUMPER

- Made of 1.5" (3.8 cm) diameter steel tubing with durable powder coat finish and a 1/8" (3 mm) thick aluminum plate for added vehicle-front protection in extreme driving conditions.
- Sleek styling enhances the vehicle's race-inspired look.
- Not winch compatible.
- Not compatible with 10" (25 cm) Baja Designs OnX6 LED Light Bar.



Maverick X3, Maverick X3 MAX (not compatible with Xmr and Xrc models)

■ 715005510 • Hyper Silver  ■ 715005509 • Black 

\$404.99

\$364.99

LONESTAR RACING REAR BUMPER

- Made of 1.5" (3.8 cm) diameter steel tubing with durable powder coat finish.
- Provides additional vehicle-rear bodywork and exhaust system protection in extreme driving conditions.
- Sleek styling enhances the vehicle's race-inspired look.
- Compatible with Lonestar Racing Spare Tire Holder.
- Not hitch compatible.



Maverick X3, Maverick X3 MAX

■ 715005511 • Black  ■ 715005512 • Hyper Silver 

\$384.99

\$434.99



Maverick X3, Maverick X3 MAX

■ 715004161 • Can-Am Red 

\$404.99

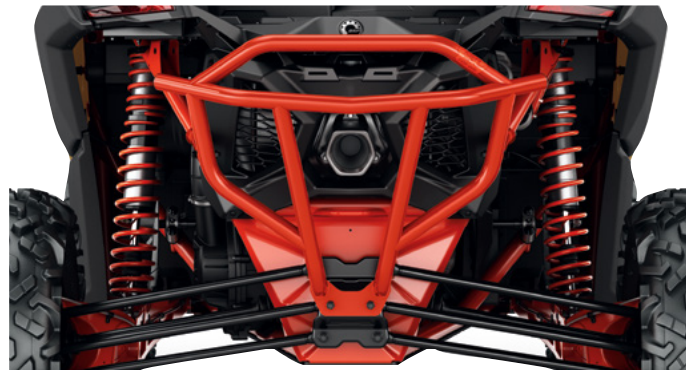

Maverick X3, Maverick X3 MAX

■ 715004162 • Can-Am Red 

\$434.99



LONESTAR RACING SPARE TIRE HOLDER

- Made of 1.5" (3.8 cm) diameter steel tubing with durable powder coat finish.
- Adjustable height to fit Can-Am tires up to 30 in.
- Requires Lonestar Racing Rear Bumper and Lonestar Racing Rear Intrusion Bar for installation.
- Cannot hold the Pro Armor Quickshot Wheel Jack and Off-Road Screw Jack.
- Wheel not included.
- Not compatible with the S&B Particle Separator and LinQ accessories intended for the rear of the vehicle.

Maverick X3, Maverick X3 MAX (except X mr models)

■ 715003922 • Black 
\$214.99

■ 715004166 • Can-Am Red 
\$259.99

■ 715006344 • Hyper Silver 
\$264.99



LONESTAR RACING NUMBER PLATE HOLDER

- Includes a pair of sturdy aluminum number plates that mount on either side of the vehicle rear.
- Not compatible with LinQ Pivoting Rack.
- Numbered decals are available through SCS Unlimited.
- Styling enhances the vehicle's race-inspired look while adding a personal touch.
- Black background.

Maverick X3, Maverick X3 MAX



715003943 
\$184.99

LONESTAR RACING FRONT INTRUSION BAR

- Made of 1.5" (3.8 cm) diameter steel tubing with durable powder coat finish.
- Enhances the racing look of the vehicle.
- Compatible with Lonestar Racing Aluminum Roof only.
- Not compatible with windshields.

Maverick X3, Maverick X3 MAX

■ 715003916 • Black 
\$394.99

■ 715004163 • Can-Am Red 
 ■ 715006342 • Hyper Silver 
\$444.99





LONESTAR RACING REAR INTRUSION BAR

- Made of 1.5" (3.8 cm) diameter steel tubing with durable powder coat finish.
- Sleek styling enhances the vehicle's race-inspired look.
- Required for the installation of the Lonestar Racing Spare Tire Holder.
- Not compatible with LinQ mounted accessories and Pre-Filter in the cargo bed.

Maverick X3 (except X mr models),

Maverick X3 MAX

■ 715003918 • Black 
\$314.99

■ 715004164 • Can-Am Red 
 ■ 715006343 • Hyper Silver 
\$364.99



LONESTAR RACING ROCK SLIDERS

- Made of 1.5" (3.8 cm) diameter steel tubing with durable powder coat finish filled with 1/8" (3 mm) aluminum plate.

- Protects vehicle sides from large obstacles.
- Sleek styling enhances the vehicle's race-inspired look.

- "Lonestar Racing for Can-Am" branded.
- Sold in pairs.
- Not compatible with X rc models.



Maverick X3

■ 715005514 • Hyper Silver 
\$364.99

■ 715005513 • Black 
\$314.99



Maverick X3 MAX

■ 715005518 • Hyper Silver 
\$734.99

■ 715005517 • Black 
\$684.99



Maverick X3

■ 715004165 • Can-Am Red 
\$364.99



Maverick X3 MAX

■ 715004343 • Can-Am Red 
\$724.99



S3 FRONT BUMPER



S3 REAR BUMPER



WHEN IT COMES TO MUD-MASTERING ACCESSORIES, S3 HAS THE EDGE IN DELIVERING PERFECT-FIT WINCH-READY BUMPERS FOR WORK, PLAY, AND RECOVERY.

S3 FRONT BUMPER

- Made of 1.5" (3.8 cm) diameter steel tubing with a 1/8" (3 mm) aluminum plate for extra durability.
- Inside and outside anti-corrosion coating with durable powder coat finish.
- Added heavy-duty protection in extreme driving conditions.
- Integrated winch support plate and mount points for lights.
- Hook support anchor allows you to keep the winch hook within easy reach when riding in deep mud.
- "S3 for Can-Am" branded.
- Winch not included.

Maverick X3, Maverick X3 MAX

■ 715004867 • Black

■ 715005231 • Can-Am Red

\$444.99

REAR WINCH HARNESS

(Not illustrated)

- Required for installation of a winch on the S3 Rear Winch Bumper.

715006007

\$194.99

S3 REAR BUMPER

- Made of extra-durable 1.5" (3.8 cm) diameter steel tubing.
- Inside and outside anti-corrosion coating with durable powder coat finish.
- Added heavy-duty protection in extreme driving conditions – protects vehicle bodywork and exhaust system.
- Permits installation of a winch at a higher location to improve accessibility in muddy conditions.
- "S3 for Can-Am" branded.
- Engineered to sustain heavy winch loads without damaging the vehicle's frame.
- Compatible with Can-Am HD and WARN VRX winches – rear winch harness 715006007 is required to install a winch on the bumper.
- Includes a robust recovery hook to facilitate vehicle recovery.
- Winch not included.
- Not EC compliant.

Maverick X3, Maverick X3 MAX

■ 715004869 • Black

■ 715005232 • Can-Am Red

\$609.99

S3 REAR PULL PLATE

- Offers a solid place to hook onto in case towing is needed.
- Allows you to attach most straps and hooks.
- "S3 for Can-Am" branded.

Maverick X3, Maverick X3 MAX

■ 715004870 • Black

■ 715005233 • Can-Am Red

\$124.99



SEAT ACCESSORIES



4-POINT HARNESS

- Exclusive controlled decelerator absorbs energy in case of an accident.
- Designed to offer maximum riding comfort.
- Easy one-click latch and release.
- Patent pending.
- Not EC compliant.

Maverick X3, Maverick X3 MAX

715008034 • Passenger
\$194.99

715008033 • Driver
\$234.99



RETRACTABLE 4-POINT HARNESS

- Convenient harness allows you to move freely in your seat, and at the same time, fully benefit from the extra support given by the 4-point attachments.
- Makes it easier to buckle up and requires fewer adjustments when switching passenger or driver.
- Retractor Protector (707900653) is required for installation on front seats of MAX models.
- Compatible with rear passenger seats on MAX models.
- Standard on Maverick X3 X rs 2018 and up and X rc Turbo R models.

Maverick X3, Maverick X3 MAX

715005022 • Passenger 
\$249.99

715005021 • Driver 
\$264.99

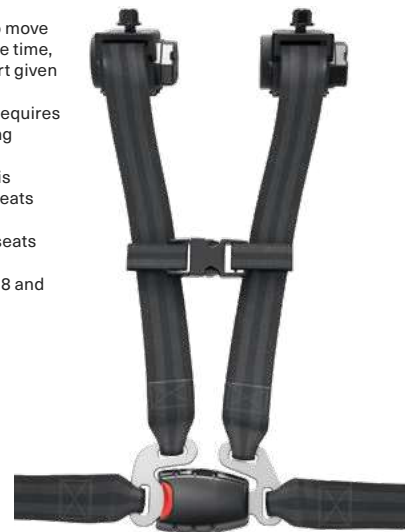

SEAT BELT SHOULDER PADS

- Provide additional riding comfort by preventing seat belt from rubbing on neck and shoulder.
- Fit with standard 3-point seat belts and Retractable 4-Point Harness.
- Easy Velcro installation.
- Can-Am branded.
- Sold in pairs for driver and passenger.

Maverick X3, Maverick X3 MAX

715002894
\$40.99



RETRACTOR PROTECTOR

(Not illustrated)

- Protective pad required for the installation of the Retractable 4-Point Harness on front seat of MAX models.
- Protects the passengers from the retractor mechanism.
- Sold individually.

Maverick X3 MAX

707900653 
\$90.99

EASY ON, EASY OFF CARGO



A BRP EXCLUSIVE, LinQ IS A TOOL-LESS SYSTEM FOR NEAR-INSTANT INSTALLATION OF ACCESSORIES. QUICKLY, EASILY INSTALL AND REMOVE LinQ ACCESSORIES TO TRANSFORM YOUR MACHINE TO FIT THE MOMENT.



LinQ ACCESSORY TYPES

- **LinQ** with 16" base accessories are mounted with LinQ anchors 16 inches apart, ideal for Can-Am ATVs and SSVs, Sea-Doo watercraft, and Ski-Doo snowmobiles.
- **LinQ** with 36" base accessories are most commonly used as part of LinQ racks for Can-Am Off-Road vehicles.



LinQ SYSTEM™ ACCESSORIES

- No tools needed: Quickly install and remove accessories by hand
- Equip your Can-Am for specialized tasks in no time
- Sturdy mounting system that holds up to the roughest terrain

MOUNTING LOCATION AND REQUIREMENTS

Standard LinQ Rack



LinQ Pivoting Rack
715002881 / 715003439







Adventure Roof Rack
715003868 / 715006225











LinQ ACCESSORIES WITH 16" BASE p. 35

- LinQ anchors mounted 16 inches apart, center to center.
- Lower loading capacity than the LinQ with 36" base accessories.
- Can be used on Can-Am ATV and SSV vehicles, Sea-Doo watercraft and Ski-Doo snowmobiles.

	LinQ 4.2 GAL (16 L) COOLER 295100698	LinQ Anchor Adapter Kit 715004960	LinQ Anchor Adapter Kit 715004960	LinQ Cargo Base Kit 860201806
	LinQ TOOL BOX 715004301			
	LinQ SR 5.5 GAL (21 L) BAG 860201740			
	LinQ 4.5 GAL (17 L) SPORT BAG 860201678			
	LinQ DRY BAG 715002875			
No further requirements				

LinQ ACCESSORIES WITH 36" BASE p. 36

- Mount on LinQ racks often used by Can-Am ORV vehicles.
- Higher loading capacity than the LinQ with 16" base accessories.
- Usage is limited to Can-Am ORV vehicles.

	LinQ 12 GAL (45 L) CARGO BOX 715003879	No further requirements	LinQ Anchor Adapter Kit 715004960	Not compatible
	LinQ 23 GAL (86 L) TRUNK BOX 715004923	No further requirements		
	LinQ 32 GAL (121 L) TRUNK BOX 715001748	*Not compatible if the LinQ Pivoting Rack is installed.		
	LinQ 11.5 GAL (43 L) AUDIO CARGO BOX 715003018	No further requirements		
	LinQ 8 GAL (30 L) COOLER BOX 715004748 • Black / 715004698 • Grey	No further requirements		
	LinQ PREMIUM STORAGE BAG BY OGIO 715002923 • Black / 715003248 • Camo	No further requirements		
	LinQ HEAVY-DUTY BASKET 715001215	No further requirements		
	LinQ LOW PROFILE BASKET 715004282	No further requirements		

LinQ RACKS & HOLDERS p. 38

	LinQ TOOL HOLDER 715003059	No further requirements	No further requirements	Side wall installation: LinQ Adapters 715003058
---	--------------------------------------	-------------------------	-------------------------	--

LinQ 4.2 GAL (16 L) COOLER

SR 5.5 GAL (21 L) LinQ BAG

LinQ TOOL HOLDER



LinQ Accessories with 16" base



LinQ 4.2 GAL (16 L) COOLER

- Rotomolded construction for exceptional rigidity and durability.
- Premium-quality foam insulation for optimal ice retention.
- Maritized for salt water purposes.
- See table for installation location and requirements.

Maverick X3, Maverick X3 MAX

295100698

\$304.99



LinQ TOOL BOX

- High precision injected HDPE construction provides rigidity and durability.
- 5 Gal (19 L) maximum capacity.
- Weather-resistant, sealed and lockable cover.
- LinQ Cargo Base Kit (860201806) included.
- Maritized for salt water purposes.
- See table for installation location and requirements.

Maverick X3, Maverick X3 MAX

715004301

\$149.99



LinQ SR 5.5 GAL (21 L) BAG

- Semi-rigid expandable bag.
- 5.5 Gal (21 L) capacity.
- LinQ Cargo Base Kit included (860201806) included.
- See table for installation location and requirements.

Maverick X3, Maverick X3 MAX

860201740

\$189.99



LinQ 4.5 GAL (17 L) SPORT BAG

- 4.5 Gal (17 L) capacity.
- Rigid bottom, semi-rigid top.
- See table for installation location and requirements.

Maverick X3, Maverick X3 MAX

860201678

\$174.99



LinQ DRY BAG

- Fully waterproof roll-top dry bag will securely store and confine your equipment.
- LinQ mounted using heavy-duty rigid plastic base.
- High capacity storage solution (40 L).
- Bottom foam liner for additional equipment protection.
- Integrated handle for easy transportation on/off the vehicle.
- LinQ Cargo Base Kit included (860201806) included.
- Maritized for salt water purposes.
- See table for installation location and requirements.

Maverick X3, Maverick X3 MAX

715002875

\$199.99





LinQ 23 GAL (86 L) TRUNK BOX

LinQ Accessories with 36" base



LinQ 12 GAL (45 L) CARGO BOX

- LinQ mounted for easy on, easy off installation.
- Holds cargo safely and securely while riding.
- See table for installation location and requirements.

Maverick X3, Maverick X3 MAX

715003879 \$229.99



LinQ 23 GAL (86 L) TRUNK BOX

- LinQ mounted for easy on, easy off installation.
- Lockable and weather-resistant.
- Holds cargo safely and securely while riding.
- See table for installation location and requirements.

Maverick X3 (except X mr models), Maverick X3 MAX

715004923 \$299.99



LinQ 32 GAL (121 L) TRUNK BOX

- Equipped with the LinQ System, the rear trunk box plugs in and out in seconds.
- 32 Gal (121 L) load capacity with unobstructed space to maximize storage room and access to the trunk's interior.
- Made of injection-molded polyethylene, double walled in critical areas.
- The fully sealed lid protects your belongings from dust, moisture and the elements.
- No rear tail light.
- Trunk Box Panels available in many colors to match your vehicle (sold separately).
- See table for installation location and requirements.

Maverick X3 (except X mr models), Maverick X3 MAX

715001748 • No rear tail light \$344.99



LinQ 32 GAL (121 L) TRUNK BOX PANELS

- Color panels to match the LinQ 32 Gal (121 L) to your vehicle.

Maverick X3, Maverick X3 MAX

European Version (EC compliant)

- No rear tail light
- 715001397 • Black
- 715001398 • Yellow
- 715002482 • Light Grey
- 715002483 • White
- 715006121 • Can-Am Red
- 715006122 • Manta Green
- 715006123 • Orange Crush
- 715006124 • Viper Red

\$51.99



EXPERT CHOICE

LinQ 8 GAL (30 L) COOLER BOX

- Installs without vehicle modification.
- LinQ mounted for easy on, easy off installation.
- Rotomolded construction provides exceptional rigidity and durability.
- Premium-quality foam insulation for optimal ice retention.
- Weather-resistant.
- Integrated, fully removable compartment protects food.
- Robust rubber latches keep the cover tightly closed.
- Convenient drain plug.
- See table for installation location and requirements.

Maverick X3, Maverick X3 MAX

- 715004698 • Grey 
- 715004778 • Black 

\$374.99

INSTALLATION 



LinQ HEAVY-DUTY BASKET

- Made of high-strength, low-alloy steel.
- LinQ mount for easy on, easy off installation.
- See table for installation location and requirements.

Maverick X3, Maverick X3 MAX

715001215 
\$229.99



LinQ LOW PROFILE BASKET

- Low profile, open basket increases cargo space.
- Perfect for easy access to tools, rope, winch and plow accessories.
- Multiple bungee cord and tie-down anchor points.
- Made of impact-resistant injected polypropylene.
- See table for installation location and requirements.

Maverick X3, Maverick X3 MAX

715004282 
\$174.99



LinQ 11.5 GAL (43 L) AUDIO CARGO BOX

- An affordable and quick solution for adding music and storage to your next ride.
- The rear installation does not use any cab space and allows for easy listening at an average speed.
- Mounts on/off easily to hold/carry cargo safely and securely.
- Backlit control panel perfect for night riding.
- Water-resistant speakers.
- The Bluetooth enabled receiver and 6.5" (16.5 cm) speakers are smartly concealed and integrated in the cover.
- Automatic shut-off function protects your battery by turning the system off after 10 minutes of inactivity.
- See table for installation location and requirements.

Maverick X3, Maverick X3 MAX

715003018 
\$589.99





EXPERT CHOICE

LinQ PREMIUM STORAGE BAG BY OGIO

- Tool-less installation and removal thanks to the LinQ System.
- 17.2 Gal (65 L) capacity semi-rigid cargo bag ideal for carrying anything you need on your vehicle.
- Buckle and elastic closure with a rubber seal that protects dust from entering the bag.
- 3-section lid for partial or full access to your bag.
- Inside separators for optimal bag organization.
- See table for installation location and requirements.

Maverick X3, Maverick X3 MAX

■ 715002923 • Black 
\$409.99

■ 715003248 • Mossy Oak Break-Up Country Camo 
\$484.99



Inside separators for optimal bag organization



LinQ TOOL HOLDER

- Ultra-versatile tool holder.
- Convenient swivel-latch allows tools to be stored in any orientation.
- Sold in pairs.
- See table for installation location and requirements.

Maverick X3, Maverick X3 MAX
 715003059
\$50.99



LinQ ANCHOR ADAPTER KIT

- Allows the installation of 16" LinQ accessories.
- Tool-less installation and removal.

Maverick X3, Maverick X3 MAX
 715004960
\$61.99



LinQ CARGO BASE KIT

- Unique mounting fastener usable on any LinQ System accessory.
- Included: 2 LinQ Cargo bases and hardware.

Maverick X3 MAX
 860201806
\$29.99



TUBE LinQ ADAPTER

- Cage mounted LinQ receiver.
- Included in the LinQ Pivoting Rack assembly.
- Allows the installation of single LinQ mounted accessory.
- Diameter: 1.85" (47 mm).

Maverick X3, Maverick X3 MAX
 715004292
\$26.99



LinQ REPLACEMENT PART

- (Not illustrated)
- Unique mounting fastener usable on any LinQ System accessory.
 - Tool-less installation and removal.
 - Sold in pairs.

Maverick X3, Maverick X3 MAX
 715001707
\$22.99

LinQ ADAPTER

- (Not illustrated)
- Allows the installation of the LinQ Tool Holder (715003059) on the Adventure Roof Rack.
 - Sold in pack of 4.

Maverick X3 MAX
 715003058
\$26.99

CARGO BOX NET

- (Not illustrated)
- Solid net designed to secure and assure a compact confinement of your Adventure Roof Rack cargo.

Maverick X3, Maverick X3 MAX
 715001371
\$61.99



LinQ PIVOTING RACK

SPARE TIRE RATCHET TIE-DOWNS

- 3-way ratcheting tie-down strap with loop ends.
- Designed to securely hold spare tires on accessories equipped with integrated spare tire attachment points.
- Adjustable to accommodate most common UTV tire sizes.
- Ratchet and junction ring made of durable zinc-plated steel.
- Required for spare tire attachment on Adventure Roof Rack.

Maverick X3 (except X mr models), Maverick X3 MAX
 280000606
\$27.99



CARGO & RACKS

EXPERT CHOICE

ADVENTURE ROOF RACK

- Ideal cargo solution for packing everything you need to live your Off-Road experience fully and completely.
- Built with light weight 1.25" (3.2 cm) diameter steel tubing.
- Integrated mounting points for lights can hold up to eight pod-type LED lights (six front and two back) or a 40" (102 cm) LED bar (front).
- Features anchor points for spare-tire attachment.
- LinQ anchor on both side.
- Spare Tire Tie-Downs sold separately.
- Add the Cargo Box Net to secure and confine your cargo in the rack.
- Loads up to 75 lb (34 kg).

NEW **Maverick X3**

715006225

\$549.99

Maverick X3 MAX

715003868

\$599.99



BUILD YOUR OWN ADVENTURE ROOF RACK!

Shown here with:
Spare Tire with Tie-downs
Baja Designs XL80
LED Lights and LinQ
tool holders.



EXPERT CHOICE

LinQ PIVOTING RACK

- LinQ latched rack allows for extra LinQ mounted accessories or for carrying a spare tire (tire not included).
- Includes custom tie-down strap for fast spare tire installation or removal.
- Gas-cylinder pivot action, locks in the raised position.
- Trunk Boxes over 20 Gal (74 L) do not fit on the vehicle when the rack is installed.
- Not compatible with Rear Intrusion Bars, Rear Cage Extension and Lonestar Racing Aluminum Roofs.

Maverick X3 (except X mr models), Maverick X3 MAX

■ 715002881 · Black

\$469.99



INSTALLATION ▶

■ 715003439 · Can-Am Red

\$524.99



EXPERT CHOICE

SHOULDER STORAGE BAG

- Bag attaches in unused space between the seats to increase your vehicle's cargo capacity.
- Installs between the rear seats only on MAX models.

Maverick X3 (except X mr models), Maverick X3 MAX (rear only)

715004277  **\$99.99**

INSTALLATION 



FRONT SHOULDER STORAGE BAG

- Opens on each side so that both front and rear passengers can access the bag's content.
- Installs between the driver and passenger seats on MAX models.

Maverick X3 MAX

715004888  **\$134.99**

INSTALLATION 



OVERHEAD STORAGE BAG

- Weather-resistant bag, holds your gear safely and securely while riding.
- Makes smart use of your overhead space to increase your vehicle's cargo capacity by 2.6 Gal (10 L).
- Semi-rigid construction renders it flexible enough to fit odd-shaped loads.
- Touchscreen-compatible clear front pocket allows for easy access to your smartphone.
- Not compatible with the Bimini Roof.

Maverick X3, Maverick X3 MAX

715004275  **\$99.99**



UPPER DOOR STORAGE BAGS

- Weather-resistant, they'll hold your gear safely and securely while riding.
- Bags attach on stock quarter doors to increase your vehicle's cargo space.
- Each bag is designed as a 1.3 Gal (5 L) capacity pocket also equipped with inner netting compartments.
- Semi-rigid construction renders them flexible enough to fit odd-shaped loads.
- Sold in pairs.

Maverick X3, Maverick X3 MAX

715004276  **\$124.99**



LOWER DOOR PANEL STORAGE BAGS

- Weather-resistant, they'll hold your gear safely and securely while riding.
- Bags attach on Lower Door Panels to increase your vehicle's cargo space.
- Each bag is designed as a 1.6 Gal (6 L) capacity pocket also equipped with inner netting compartments.
- Semi-rigid construction renders them flexible enough to fit odd-shaped loads.
- Sold in pairs.
- Not compatible with aluminum doors and Off-Road Screw Jack.
- Lower add-on doors required for installation.

Maverick X3, Maverick X3 MAX

715004355  **\$159.99**



SOFT STORAGE BAG

(Not illustrated)

- 11.8 Gal (45 L) capacity soft cargo bag designed with vehicle's rear in mind to maximize potential storage.
- 3 sections.
- Weatherproof.

Maverick X3, Maverick X3 MAX

715003759 • Black  **\$154.99**

STORAGE 2.6 GAL (10 L) BAG

- Roll-top dry bag for fully protecting your cargo from the elements.

Maverick X3, Maverick X3 MAX

269502121  **\$32.99**





BUILD YOUR LIGHTING SYSTEM

Refer to p. 46

DEVELOPED BY THE SCIENTISTS OF LIGHTING TO SHINE FARTHER AND SURVIVE BEYOND THE BEATEN PATH— ALL WITH A LIFETIME WARRANTY.

EXPERT CHOICE

40" [102 CM] BAJA DESIGNS ONX6 ARC LED LIGHT BAR

- 252W light bar producing 29,000 lumens.
- Equipped with 24 Cree XM-L2 LEDs.
- Driving/Combo light pattern for smooth blend of light for both near field applications and distance.
- Designed for installation onto Light Support Bar equipped roofs.
- Requires Light Power Cable and Light Support Bar.

Maverick X3, Maverick X3 MAX

710006818

\$1,779.99 



29,000 LUMENS

40" (102 cm) OnX6 Arc Combo

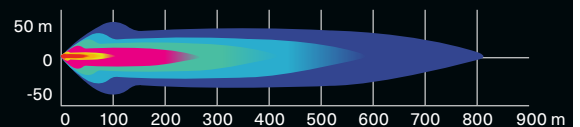

10" (25 CM) BAJA DESIGNS ONX6 LED LIGHT BAR

- 108W light bar producing 12,460 lumens.
- Equipped with 6 Cree XM-L2 LEDs.
- Driving/Combo light pattern for smooth blend of light for both near field applications and distance.
- Dual intensity (high/low) settings.
- Designed for installation onto Pre-Runner and Dune bumpers and/or Light Support Bar equipped roofs.
- Requires Light Power Cable.

Maverick X3, Maverick X3 MAX

710006819

\$469.99



12,460 LUMENS

10" (25 cm) OnX6 Combo

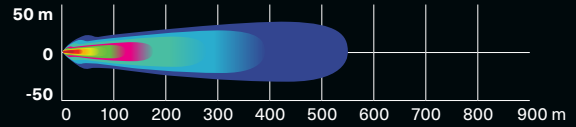

BAJA DESIGNS XL SPORT LED LIGHTS

- 26W per spot producing 3,150 lumens.
- Equipped with 4 Cree XP-G2 LEDs per spot.
- High Speed Spot features a longer and narrower beam focus for illumination farther down.
- Designed for installation onto Pre-Runner and Dune bumpers and/or Light Support Bar equipped roofs.
- Require Light Power Cable.
- Sold in pairs.
- Dimensions: 4.5" x 4.5" (11.4 cm x 11.4 cm).

Maverick X3, Maverick X3 MAX

710006821

\$439.99



3,150 LUMENS

XL Sport Spot

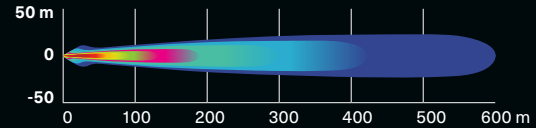

BAJA DESIGNS SQUADRON SPORT LED LIGHTS

- 26W per spot producing 3,150 lumens.
- Equipped with 4 Cree XP-G2 LEDs per spot.
- Designed for installation onto Pre-Runner and Dune bumpers and/or Light Support Bar equipped roofs.
- Wide cornering light pattern designed specifically for cornering, dust and/or fog conditions.
- Require Light Power Cable.
- Sold in pairs.
- Dimensions: 3" x 3" (7.6 cm x 7.6 cm).

Maverick X3, Maverick X3 MAX

710006820

\$254.99



3,150 LUMENS

Squadron Sport Wide Cornering

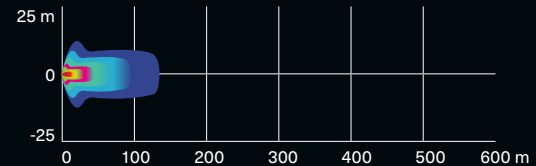

BAJA DESIGNS XL80 LED LIGHTS

- 80W per spot producing 9,500 lumens.
- Equipped with 4 Cree XHP50 LEDs per spot.
- Dual intensity (high/low) settings.
- Driving/Combo light pattern for smooth blend of light for both near field applications and distance.
- Designed for installation onto Pre-Runner and Dune bumpers and/or Light Support Bar equipped roofs.
- Require Light Power Cable.
- Sold in pairs.
- Dimensions: 4.5" x 4.5" (11.4 cm x 11.4 cm).

Maverick X3, Maverick X3 MAX

710005041

\$884.99



9,500 LUMENS

XL80 Combo

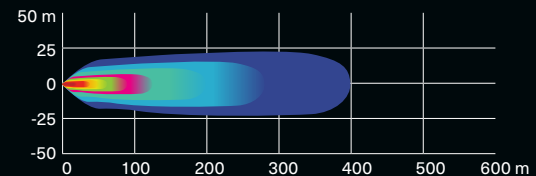

BUILD YOUR LIGHTING SYSTEM. Refer to [p. 46](#)



LONESTAR RACING LIGHT RACK

LOW-PROFILE LIGHT MOUNT SOLUTION FROM LONESTAR RACING.



LONESTAR RACING 40" (102 CM) LED LIGHT BAR RACK

- Designed for use with 40" (102 cm) Baja Designs OnX6 Arc LED Light Bar.
- Enhances the vehicle's race-inspired look.
- Compatible with Aluminum Roof, Lonestar Racing Aluminum Roof and Sport Roof.
- Not compatible with Racing Side Mirrors and PowerFlip Windshield.
- Lights sold separately.

Maverick X3, Maverick X3 MAX

715003920



\$314.99



LONESTAR RACING LIGHT RACK

- Designed for use with Baja Designs XL80 LED Light and Baja Designs XL Sport LED Light.
- Accommodates up to two pairs of XL Lights.
- Not compatible with Racing Side Mirrors and PowerFlip Windshield.
- Compatible with Lonestar Racing Aluminum Roof, Aluminum Roof and Sport Roof.
- Lights sold separately.

Maverick X3, Maverick X3 MAX

715003948



\$314.99



CHASE LIGHTS

- Designed by Can-Am to make you visible to vehicles riding behind you, especially in dusty or harsh conditions.
- Feature in-dash switches to activate one of the two modes and to choose among 11 different high-visibility colored light patterns (blue, red and yellow).
- Trail Mode: Serves as a tail light and as a brake light.
- Race Mode: Displays light patterns and serves as a brake light (brake light function can be deactivated for racing applications).
- Modular to allow installation with rear roll cage mounted accessories.
- Plug-and-play installation.

Maverick X3, Maverick X3 MAX

715002887



\$629.99



LIGHT SUPPORT BAR

- Sleekly styled rugged aluminum construction.
- Accommodates light bars and spotlights with or without any roof and windshield combination.
- Full vehicle width to allow the installation of any large LED light bar.
- Required for light installation on vehicle's roof.
- Not compatible with Lonestar Racing Aluminum Roof.
- Lights sold separately.

Maverick X3, Maverick X3 MAX

715003529



\$214.99



MOUNTING KIT FOR 39" (99 CM) LED LIGHT BAR

(Not illustrated)

- Required for installation of the 39" (99 cm) Double Stacked LED Light Bar.
- Includes wiring and support bracket.
- Light Support Bar required for installation.

Maverick X3, Maverick X3 MAX

715005822



\$104.99

LIGHT POWER CABLE

(Not illustrated)

- Required for installation of 10" (25 cm), 15" (38 cm) and Double Stacked LED Light Bars and 4" (10 cm) Round LED Lights.
- For bumper and roof mounting locations.

Maverick X3, Maverick X3 MAX

715003417



\$50.99

39" (99 CM) DOUBLE STACKED LED LIGHT BAR (270 WATTS)

- Equipped with 54 5W Cree LEDs.
- 24,300 lumens.
- See table for mounting location and installation.

Maverick X3, Maverick X3 MAX

715004007 
\$744.99



15" (38 CM) DOUBLE STACKED LED LIGHT BAR (90 WATTS)

- Equipped with 18 5W Cree LEDs.
- 8,400 lumens.
- Rugged and waterproof.
- EC compliant.
- See table for installation location.

Maverick X3, Maverick X3 MAX

715002934 
\$379.99



10" (25 CM) DOUBLE STACKED LED LIGHT BAR (60 WATTS)

- Equipped with 12 5W Cree LEDs.
- 5,400 lumens.
- Rugged and waterproof.
- Packs a big punch for its size.
- EC compliant.
- See table for installation location.

Maverick X3, Maverick X3 MAX

715002933 
\$309.99



4" (10 CM) ROUND LED LIGHTS (2 X 25 WATTS)

- 25W LED spotlights.
- 1,800 lumens.
- Rugged and waterproof.
- Includes basic wiring and switch.
- Can-Am branded grill.
- Sold in pairs.
- Not EC compliant.
- See table for installation location.

Maverick X3, Maverick X3 MAX

715002935 
\$379.99



24,300 LUMENS

Lights up to more than 2,900 ft (900 m) in front of the vehicle and around 115 ft (35 m) wide on each side.

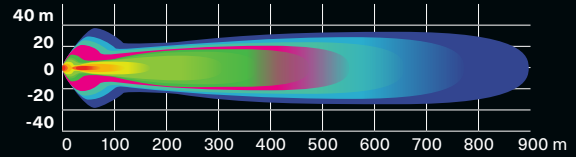

8,400 LUMENS

Lights up to more than 1,900 ft (580 m) in front of the vehicle and around 65 ft (20 m) wide on each side.

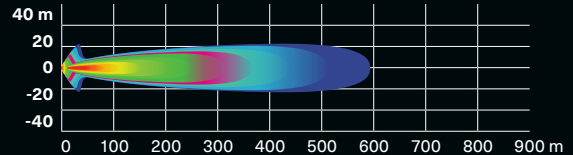

5,400 LUMENS

Lights up to more than 1,500 ft (460 m) in front of the vehicle and around 65 ft (20 m) wide on each side.

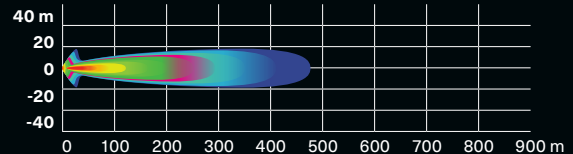

1,800 LUMENS

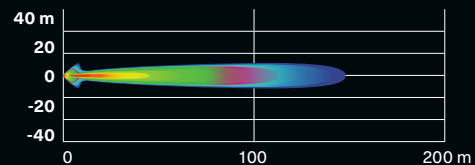

BUILD YOUR LIGHTING SYSTEM. Refer to [p. 46](#)



FOCUSED & POWERFUL LED DRIVING AND FLOOD LIGHTS FOR TOTAL CONFIDENCE AT ANY TIME.

3.5" (9 CM) LED LIGHTS (2 X 14W)

- 14W LED lights producing 1,260 lumens each.
- Equipped with 6 high power LEDs in a heavy-duty die cast aluminum housing.
- Features 2 attachment points — if one attachment point fails due to a collision, rotate to the next channel point and re-mount the light.
- Sold in pairs.
- EC compliant.

Maverick X3, Maverick X3 MAX

LED DRIVING LIGHTS

- Spot lens for a narrow and long light beam spread, ideal when driving at higher speeds.

715003666 
\$214.99

LED FLOOD LIGHTS

- Flood lens for a wide light beam spread, ideal for working applications like plowing or for cornering, dusty or foggy riding conditions.

715003665 
\$214.99



1,260 LUMENS

LED Driving Lights

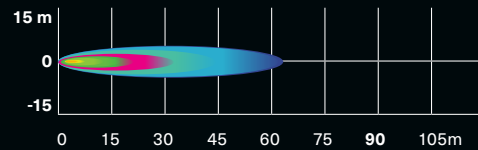

LED Flood Lights

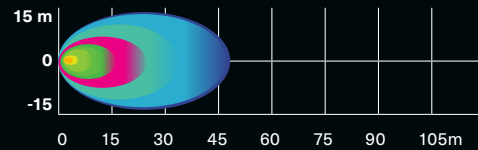

CAN-AM LED SIGNATURE LIGHTS

- Add style with a more aggressive look.
- Use bright and energy efficient LEDs.
- Do not give additional lighting for driving.

Maverick X3, Maverick X3 MAX

715003673 
\$214.99



DOME LIGHT

- LED array integrates perfectly with vehicle.
- Wiring included.
- Can be installed on cage or roof, with or without roof liner.

Maverick X3, Maverick X3 MAX

715002455 
\$71.99



BUILD YOUR LIGHTING SYSTEM. Refer to [p. 46](#)



BUILD YOUR LIGHTING SYSTEM IN 3 EASY STEPS.

1 CHOOSE YOUR MOUNT POINT	2 CHOOSE YOUR LIGHTS								
	BAJA DESIGNS LIGHTS				CAN-AM LIGHTS				
	10" (25 cm) LED Light Bar	40" (102 cm) Arc LED Light Bar ONX6	XL Sport LED lights (sold in pairs)	XL80 LED Lights (sold in pairs)	10" (25 cm) Double Stacked LED Bar	15" (38 cm) Double Stacked LED Bar	39" (99 cm) Double Stacked LED Bar	4" (10 cm) Round LED Lights (sold in pairs)	3.5" (9 cm) LED Driving Lights or Flood LED Lights (sold in pairs)
	Consult p.41-42 for more information on these lights.				Consult p.43-45 for more information on these lights.				
Front Pre-Runner or Dune Bumpers	710006819 PLUS 715007049 (Power Cable)	NA	710006821 PLUS 715002884 (Power Cable)	710005041 PLUS 715007049 (Power Cable)	715002933 PLUS 715003417 (Power Cable)	715002934 PLUS 715003417 (Power Cable)		715002935 PLUS 715003417 (Power Cable)	715003666 or 715003665 PLUS 715003417 (Power Cable)
Lonestar Racing Front Bumper	NA	NA	710006821 PLUS 715002884 (Power Cable)	710005041 PLUS 715007049 (Power Cable)				715002935 PLUS 715003417 (Power Cable)	715003666 or 715003665 PLUS 715003417 (Power Cable)
Light Support Bar or Adventure Roof Rack	710006819 PLUS 715007049 (Power Cable)	710006818 PLUS 715007117 (Power Cable)	710006821 PLUS 715002884 (Power Cable)	710005041 PLUS 715007049 (Power Cable)	715002933 PLUS 715003417 (Power Cable)	715002934 PLUS 715003417 (Power Cable)	715004007 PLUS 715005822 (Light Mounting Kit)	715002935 PLUS 715003417 (Power Cable)	715003666 or 715003665 PLUS 715003417 (Power Cable)
Lonestar Racing 40" (102 cm) LED Light Bar Rack	NA	710006818 PLUS 715007117 (Power Cable)	NA	NA	NA	NA	NA	NA	NA
Lonestar Racing Light Rack	NA	NA	710006821 PLUS 715002884 (Power Cable)	710005041 PLUS 715007049 (Power Cable)	NA	NA	NA	NA	NA

3 ORDER **ORDER ALL PART NUMBERS IN INTERSECTING BOX**
 *Note: when installing more than one light kit, additional light power cable or mounting kit is required.

*All lights are intended for Off-Road use only.

BAJA DESIGNS LIGHT POWER CABLE

(Not illustrated)
 • Required for installation of Baja Designs LED lights onto roof or bumper.

Maverick X3, Maverick X3 MAX

10" (25 cm) Baja Designs OnX6 LED Bar and Baja Designs XL80 LED Lights
715007049
\$94.99

Baja Designs XL Sport LED Lights & Baja Designs Squadron Sport LED Lights
715002884
\$61.99

40" (102 cm) Arc LED Light Bar ONX6
715007117
\$97.99

AUDIO & COMMUNICATION SYSTEMS

YOUR RIDE, YOUR TRAIL, YOUR TUNES: PUMP UP THE VOLUME WHEREVER YOU MAY ROAM WITH THESE RUGGEDLY ENGINEERED AUDIO ACCESSORIES!

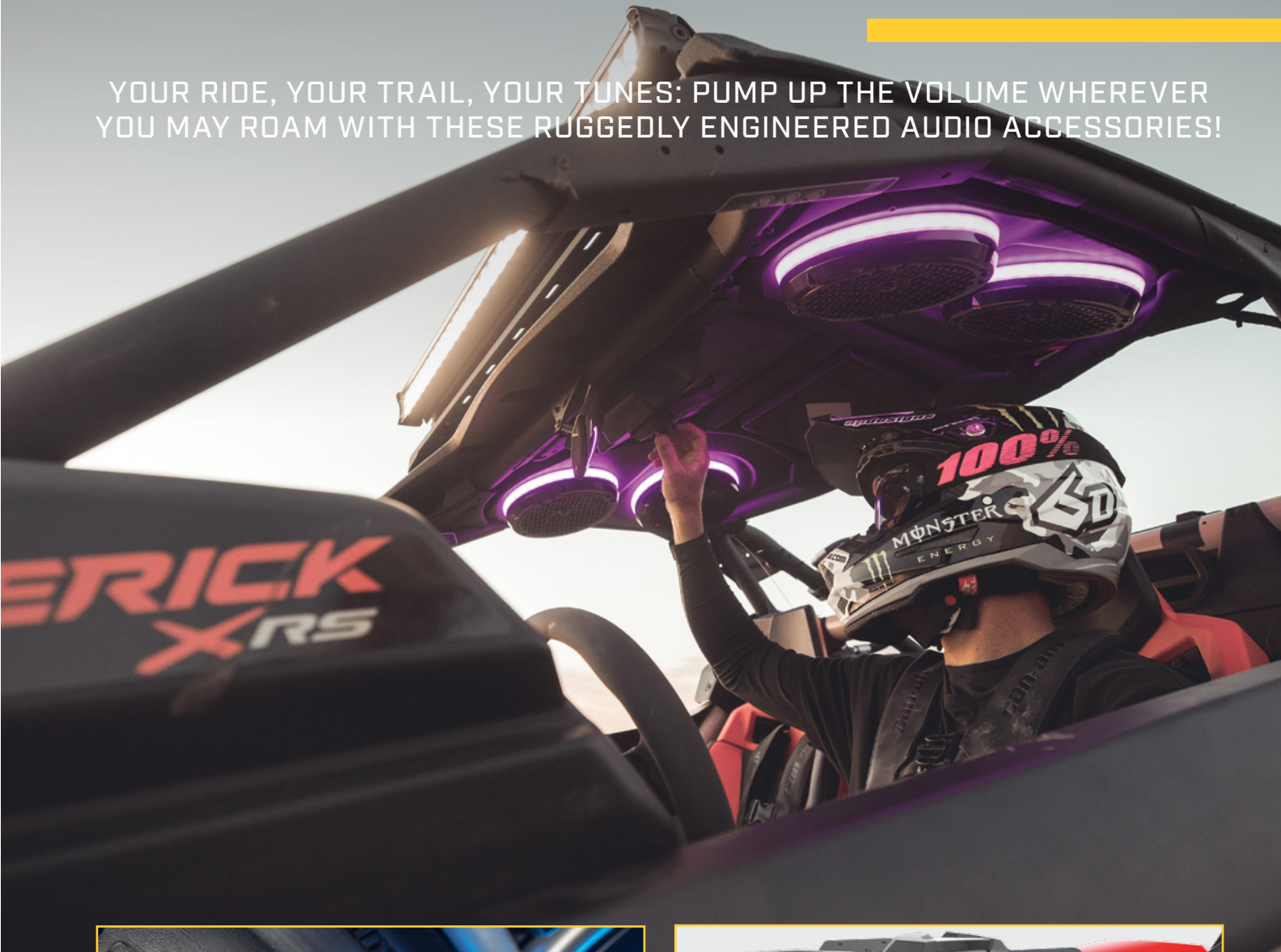

AUDIO ROOF

Part punchy stereo, part roof—upgrade your Maverick X3 instantly with a single plug.



ELECTRONIC DEVICE HOLDER

Adjustable, secure mount to take your smartphone, tablet, or electronic device along for the ride!

HEART-POUNGING SOUND
PERFORMANCE TO MATCH
YOUR MAVERICK X3.



**EXPERT
CHOICE**

AUDIO ROOF

- Full roof with sleek, built-in audio.
- Fully sealed and waterproof.
- Easy to install: One wire connects the roof to the vehicle's electronics.
- One 400 RMS and 800 Peak Watt amplifier, and one Head Unit supplied by Rockford Fosgate Audio.
- Multi-coloured RGB LED accent lighting around each speaker.
- 2.7" Colour Display with Bluetooth and Pandora connectivity.

Maverick X3

Four 8" speakers

715004900

\$2,599.99 

INSTALLATION 

NEW Maverick X3 MAX

Six 8" speakers

715006709

\$3,749.99



CAN-AM SUBWOOFER

- Powerful Rockford Fosgate Underseat 10" Subwoofer speaker box.
- Easy plug-and-play connections to Audio Roof system (wiring included).
- Sturdy construction tough enough to withstand harsh environments and sealed against moisture and dirt.
- Requires 1 Amplifier kit (715007227) for 1 or 2 subwoofers.
- Fits two per vehicle: under driver or passenger seat.

Maverick X3, Maverick X3 MAX

715004956

\$499.99



CAN-AM AMPLIFIER KIT

- A powerful 400 W amplifier to feed up to two Underseat Subwoofers.
- Easy plug-and-play connections to Audio Roof system and subwoofer.
- Installation plate and wiring included.

Maverick X3, Maverick X3 MAX

715007227

\$499.99



MTX CENTRAL SPEAKERS

- Top mounted central speaker case holding two 6.5" (16.5 cm)/100W speakers.
- Designed to be Can-Am-tough in the most demanding riding conditions.
- Perfect add-on to the Complete MTX Audio System for a 7-speaker system or as a stand-alone system by plugging the AUX input jack directly into your music device.
- Not compatible with LoneStar roofs.

Maverick X3 MAX
 715004748 
\$699.99

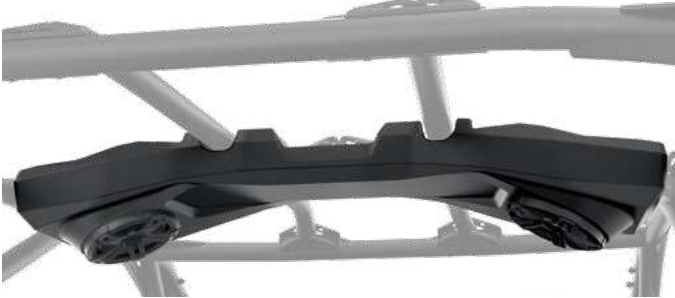

COMPLETE MTX AUDIO SYSTEM

- Bluetooth 5⁺ equipped 400W RMS/800W peak audio system by MTX.
- Designed to be Can-Am-tough in the most demanding riding conditions.
- Includes front-dashboard and rear-roll-cage mounted stereo speakers and head unit with an integrated 6.5" (16.5 cm) subwoofer.
- Add the Electronic Device Holder to securely hold your Bluetooth device ready to play your favorite tunes.

Maverick X3, Maverick X3 MAX
 715002873 
\$1,169.99



RUGGED RADIOS CAR-TO-CAR SYSTEM

- Perfect for communicating with friends and family on group rides.
- Push-to-talk button conveniently mounted on the steering wheel.
- Includes radio mounting bracket, helmet speaker, mic kit and base charger.
- May be synched with the Rugged Radios Intercom System (715002891).
- 2-4 mile range.

- This kit includes:**
- RH-5R Rugged Radios 5-Watt Dual Band Handheld Radio
 - Helmet Speaker/Mic Kit
 - Push-to-talk buttons
 - Mounting bracket
 - Base station charger

Maverick X3, Maverick X3 MAX
 715003440 
\$359.99



EXPERT CHOICE

ELECTRONIC DEVICE HOLDER

- A great in-ride entertainment system platform.
- Robust injected-polypropylene construction allows for right fit and easy installation.
- Adjustable unit safely holds most tablets and smartphones measuring between 5.1" (13 cm) and 10" (25.4 cm) (with protective case).
- Combines seamlessly with Complete MTX Audio System and Rugged Radios Intercom System.
- Allows the installation of Garmin Montana 680T GPS.
- Integrated storage (1 Gal [3.8 L] capacity) with access to the dash 12V outlet for device charging.

Maverick X3, Maverick X3 MAX
 715002874 
\$149.99

INSTALLATION 



Integrated storage with access to the 12V outlet for device charging

RUGGED RADIOS INTERCOM SYSTEM

- Specifically designed to facilitate clear in-vehicle communication between driver and passenger(s).
- Expandable to 4 people.
- Includes music port for enjoying your favorite tunes.
- Seamless integration with in-dash switch panel.
- May be synched with the Rugged Radios Car-To-Car System (715003440).

Maverick X3, Maverick X3 MAX
 715002891 
\$639.99



RUGGED RADIOS HELMET HEADSET KIT FOR REAR PASSENGERS

- Additional 12' (3.7 m) cables and Helmet Speaker/Mic Kits to upgrade your 2-person intercom system into a 4-person system.

With Rugged Radios Intercom System
 715004380 
\$204.99



ELECTRICAL & ELECTRONIC



AUXILIARY BATTERY INSTALLATION KIT

(Not illustrated)

- Allows you to add a second 18Ah battery for a dual battery setup necessary to power auxiliary electrical components such as sound systems or winches.
- Equipped with an IP67-rated waterproof electronic module that will prevent your auxiliary electrical components from draining your starting battery.
- Kit includes an additional battery junction block, all necessary wiring and the battery holder.
- Both batteries are perfectly integrated, in stock location, behind the passenger seat.
- Additional battery (410301203), plus battery hardware (250000282) sold separately.

Maverick X3, Maverick X3 MAX

715006315

\$264.99



QUICK CONNECT CABLE WITH BATTERY INDICATOR

- Quickly and easily connect and charge different batteries with your charger.
- 3-color LED indicator provides constant battery health indication.
- Sold individually.

715006055

\$20.49



QUICK CONNECT BATTERY CABLE

- Quickly and easily connect and charge different items with your charger.
- Included in the Battery Charger/Maintainer (715005061).
- Sold individually.

715005408

\$9.29



BATTERY CHARGER/MAINTAINER

- Keeps stored lead-acid batteries charged.
- Charges and maintains small batteries.
- Microprocessor controlled multi-stage charging for added precision, safety and battery life.
- Automatically detects 6 or 12 volt batteries.
- Reverse hook-up protection helps protect battery and charger from damage.
- Press the display button to show the charge progress.
- Content: 3 amp battery charger, clamp adapter, DC adapter, 24" fused ring leads harness with weather cap, owner's manual.

715005061

\$56.99



JUMP STARTER

- IPX3 water-resistant and enclosed output ports.
- 4 LED battery indicators for easy read on battery charge level.
- Compact design, will conveniently fit in your backpack, glove box or any other storage compartment.
- 2.4A + 1A/5V USB ports for fast charging of all USB devices.
- Smart cable provides protection against reverse polarity, short circuit, low voltage, high temperature and reverse charging.
- Built-in LED light (3 modes).
- Content: 300CA jump starter, SA858 smart cable clamp, MC-USB to USB charging cable, travel bag, user manual.

715005062

\$124.99



LIGHTED WHIP FLAG

- A must for riding the dunes.
- 5W Cree LED.
- 5 colored lenses to allow personalization.
- Glow-through whip, quickly removable and replaceable pole.
- Increases vehicle's visibility.
- Meets most dune-area requirements.
- Die cast aluminum base, acetal hand nut.
- Includes mounting brackets and wiring.
- 4' (1.2 m) flag mounts on top of the roll cage.
- Can be installed on both sides of a vehicle.

Maverick X3, Maverick X3 MAX

715002886

\$264.99

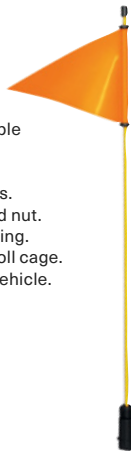

GARMIN MONTANA⁺ 680T GPS

- Rugged and waterproof, the Montana 680T is element-proof.
- 4" dual-orientation, sunlight-readable touchscreen and glove-friendly touchscreen display to give you vivid colors and high-resolution images.
- 8-megapixel autofocus camera automatically geotags photos.
- Tracks both GPS and GLONASS satellites for improved positioning and typically faster fixes.
- Preloaded TOPO maps, plus 1-year BirdsEye Satellite Imagery subscription.
- 3-axis compass with barometric altimeter.
- Electronic device holder (715002874) is required for installation.
- Includes a preloaded map for US.

Maverick X3, Maverick X3 MAX

715002830

\$684.99



European Version

- EC compliant.
 - Includes preloaded European recreation map.
- 715003456



CANADIAN MAP FOR GARMIN MONTANA 680T GPS

(Not illustrated)

- Additional and readily programmable Canadian basemap for Garmin Montana 680T GPS system.
- Requires Garmin Montana 680T GPS (715002830).

710005065

\$154.99



HEATED SEAT

- 25W seat heater delivers chill-free riding comfort.
- Hi/Low temperature settings allow you to control the desired degree of warmth.
- This kit includes one carbon fiber seat heater, foam sheet and in-dash switch.
- Installs directly in the original seat cushion.
- Heated Accessories Wiring Harness (710005757) is required for front seats installation.
- Harness (715006004) is required for rear-seat installation.

Maverick X3, Maverick X3 MAX

715006112

\$124.99

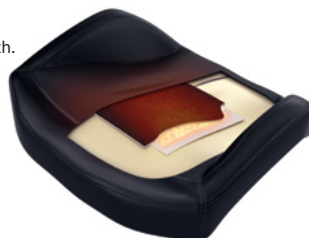

USB POWER OUTLET KIT

- Recharges your electronic devices while riding* (smartphone, MP3, heating gear, etc.).
- Dual port USB connectors.
- *The power outlet is not capable of recharging all device types while riding.

Maverick X3, Maverick X3 MAX

219400510

\$31.99



HEATED VISOR OUTLET

- Strategically positioned on vehicle to maintain your agility.
- Optional visor outlet that delivers fog-free riding.
- Quick and easy installation.
- Sold individually.
- Heated Visor not included.

Maverick X3, Maverick X3 MAX

715001246

\$50.99

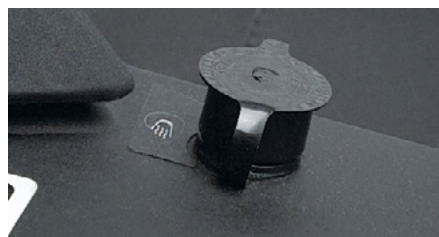

HEATED ACCESSORIES WIRING HARNESS

(Not illustrated)

- Electric harness required to hook up and operate front heated seats, heated steering wheel and grab bar.

Maverick X3, Maverick X3 MAX

710005757

\$104.99



WINCHES & HITCHES

WARN† VRX

- Extreme IP68-rated waterproof sealing keeps the elements out.
- Durable all-metal construction.
- Black powder-coated finish and stainless steel fasteners for corrosion resistance.
- Robust clutch design based on 70+ years of WARN 4WD hub lock know-how.
- Load-holding brake for great control.
- Smooth and reliable all-metal three-stage planetary gear train.
- Dash-mounted rocker control and corded remote.
- Limited lifetime warranty (mechanical), 3-year warranty (electrical).
- Pulling strength capability of 4,500 lb (2,041 kg).

WARN VRX 45 WINCH

- 50 ft. of 1/4" (15 m of 6.3 mm) wire steel cable.
- Roller fairlead.
- Winch Electrical Harness (715003585) and a winch compatible bumper are required for installation.

Maverick X3, Maverick X3 MAX

715006110

\$544.99



WARN VRX 45-S WINCH

- 50 ft. of 1/4" (15 m of 6.3 mm) synthetic rope.
- Cast aluminum fairlead.

Maverick X3, Maverick X3 MAX

715006111

\$649.99



CAN-AM HD HAWSE FAIRLEAD

- A must when upgrading your winch with a synthetic cable, this corrosion-proof aluminum hawse fairlead will prevent the cable from snapping in a corner of a roller fairlead and from wearing prematurely due to the rough surface of the worn roller guide.
- Must be used with synthetic cables only.

Can-Am HD winch

715006426

\$50.99



CAN-AM HD

- Ergonomic clutch handle.
- Rugged all-steel gears and bushings for more torque and durability.
- Automatic 100% load-holding brake.
- Sealed solenoid for all-weather protection.
- Weather sealed corded remote and dash mounted switch.
- EC compliant.

CAN-AM HD 4500

- Pulling strength capability of 4,500 lb (2,041 kg).
- 43' of 15/64" (13.1 m of 6.3 mm) wire steel cable.
- Heavy-duty 4-way roller fairlead.
- Winch Electrical Harness (715003585) and a winch compatible bumper are required for installation.

Maverick X3, Maverick X3 MAX

715006416

\$319.99



EXPERT CHOICE

CAN-AM HD 4500-S

- Pulling strength capability of 4,500 lb (2,041kg).
- 50' of 1/4" (15.2 m of 6.35 mm) wire synthetic cable.
- Corrosion-proof aluminum hawse fairlead.

Maverick X3, Maverick X3 MAX

715006417

\$434.99



WARN HAWSE FAIRLEAD

- Double-powder-coated construction.
- Required to use the Synthetic Winch Cable (705015070) on Warn winches.
- To be used with synthetic winch cables only.

705208797

\$97.99



WARN WIRED REMOTE CONTROL

- This kit allows winch owners to add the hand-held remote to their stock winch.
- EC compliant.
- Harness (710001023) is required to use remote control on a vehicle with a factory installed winch.

With Warn winch

710001002 
\$61.99



CAN-AM HD WIRED REMOTE CONTROL

- This kit allows winch owners to add the hand-held remote to vehicles with their stock winch.
- EC compliant.
- Remote control (710007050) and connection socket are included.

With Can-Am HD winch

715006504
\$13.49



WIRELESS REMOTE CONTROL

- The system is quick and easy to install, thanks to a wiring harness with an integrated antenna and all necessary mounting hardware.
- Allows you to operate your winch from anywhere within a 50' (15.2 m) radius, increasing your recovery options.
- All components are weatherproof.

With Warn winch

715002542 
\$189.99



SYNTHETIC WINCH CABLE

- 50' of 1/4" (15.2 m of 6.35 mm) synthetic cable for Warn winch.
- Warn Hawse Fairlead (705208797) is required when upgrading to a synthetic cable to avoid damage and premature wear of the cable.

With Warn winch

705015070 
\$149.99

- 50 ft. of 3/16" (15.2 m of 4.8 mm) synthetic cable for winches.
- Hawse Fairlead (715006426) required when upgrading to a synthetic cable to avoid premature cable damage and wear.

With Can-Am HD winch

715006430 
\$134.99



WIRE ROPE REPLACEMENT

- 55' of 1/4" (16.8 m of 6.35 mm) wire rope for Warn winch kit.

With Warn winch

715006699 
\$71.99

- 43' of 15/64" (14.3 m of 6.3 mm) wire rope.
- 4,500 lb (2,041 kg) pulling strength.

With Can-Am HD winch

705014978 
\$20.49



WINCH ELECTRICAL HARNESS

(Not illustrated)

- Required for winch installation.

Maverick X3, Maverick X3 MAX

715003585 
\$99.99

SYNTHETIC CABLE EXTENSION

- Lightweight 1/4" (6.3 mm) diameter, easy to handle and won't rattle in cargo box.
- Easily attaches to winch cable to provide additional 50' (15.2 m) of distance.
- 4,500 lb (2,041 kg) single line capacity.

715001120 
\$149.99



X rc / X mr REAR TOW HOOK

- Offers a solid place to hook onto in case towing is needed.
- Allows you to attach most straps and hooks.
- Made of rugged 3/16" (5 mm) steel plate and 5/8" (16 mm) steel hook tube.
- Standard on Maverick X rc and X mr models.

Maverick X3, Maverick X3 MAX

715004450 
\$70.99



REAR HITCH

- Rugged lightweight steel construction.
- E-coated finish.
- Fixed mounting point for trailer ball to provide vehicle with towing capabilities.
- This hitch offers 1,300 lb (590 kg) of towing capacity.
- Hitch ball not included.

Maverick X3, Maverick X3 MAX

■ 715002883 • Black 
\$124.99

■ 715003938 • Can-Am Red
\$159.99



PERFORMANCE



GET THE PERFORMANCE YOU CRAVE WITH UPGRADES WORTHY OF OUR RACERS.

LONESTAR RACING MUD FLAPS WITH BRACKETS

- These bolt-on mud flaps make a great addition.
- Durable chromoly brackets.
- Protect trailing arms, rotors and CVs from rocks and debris.
- Sold in pairs.

Maverick X3, Maverick X3 MAX

715004865 
\$259.99



LONESTAR RACING HEAVY-DUTY SHIFT PLATE & KNOB

- The shift plate is made from durable stainless steel and bolts into place for a secure fit.
- The kit comes with a billet aluminum Lonestar Racing shift knob.
- Offers improved durability for the performance-oriented driver.

Maverick X3, Maverick X3 MAX

715004866 
\$134.99



LONESTAR RACING OUTER TOE LINK BOXED GUSSETS

- Protect and strengthen the middle radius rod links from rough riding conditions.
- Include high-grade steel bolts.

Maverick X3, Maverick X3 MAX

715004868 
\$124.99



GRIP LIKE NEVER BEFORE



Can-Am exclusive:
Respond to Off-Road conditions like never before with 4WD powered by Smart-Lok™ Technology.

Smart-Lok™ is the most advanced Off-Road differential at your command. It's a fully lockable on-the-fly front differential with electronically controlled automatic modes that always returns maximum traction in every condition, period.

1 START WITH THE SMART-LOK™ DIFFERENTIAL

SMART-LOK™ DIFFERENTIAL

- Can-Am-exclusive Smart-Lok™ technology constitutes a true full lockable on-the-fly front differential with electronically controlled automatic modes.
- Choose your differential settings according to your riding need: "2x4" for rear wheel traction only, "4x4 Front Diff Lock" for a fully locked 4-wheel drive, and "4x4 Smart Modes" that offer preset, intelligent calibrations for your type of riding.
- Using multiple input sources, "Smart Modes" will instantaneously engage locking with the right load at the right moment to procure maximum traction while retaining low-speed maneuverability, allowing for optimal placement and a feeling of confidence.
- The Smart-Lok™ Kit comes standard with the Trail Mode.
- Mud, Rock and Trail Activ modes can be added by installing an additional Smart Mode Module (sold separately) to fine-tune your riding environment.
- Requires Performance Half Shafts (2x) and Front Differential Kit for installation.

Maverick X3
produced after January 1, 2017
Maverick X3 MAX
705402371
\$1,527.99



2 GET THE SMART-LOK™ INSTALLATION KIT & PERFORMANCE HALF SHAFT

SMART-LOK™ INSTALLATION KIT

- (Not illustrated)
- Includes all necessary hardware and wiring for Smart-Lok™ Differential installation.

Maverick X3
produced after January 1, 2017
Maverick X3 MAX
2018 and prior
715004746
\$334.99

Maverick X3, Maverick X3 MAX
2019 & up
715005329
\$334.99



PERFORMANCE HALF SHAFT

- High-performance design ideal for Off-Road use, with superior wheel power and acceleration for racing, dunes and desert riding.
- Includes CVs, Shaft and Boots with the best suited geometry for your Can-Am vehicle.

Maverick X3, Maverick X3 MAX
(64" models)
705401634
\$229.99

Maverick X3, Maverick X3 MAX
(72" models)
705402048
\$229.99



3 FINE-TUNE YOUR RIDING ENVIRONMENT WITH A SMART MODE MODULE (OPTIONAL)

These modules allow you to add the **Mud, Rock or Trail Activ** Smart Mode to vehicles equipped with the Smart-Lok™ Differential Kit.
• Only one Smart Mode Module can be installed at a time.



- Designed to deliver superior traction in the deepest mud holes.
- When high engine torque and/or slippage is detected, Smart-Lok™ will fully lock the front end.
- The system will stay locked until throttle release.

MUD SMART MODE MODULE

Maverick X3, Maverick X3 MAX
715005282
\$154.99



- Designed to help cross challenging rocks.
- When high engine torque is detected at low vehicle speed, Smart-Lok™ will progressively lock the front end and will stay engaged until throttle release to prevent wheel slippage and provide optimal traction.
- The progressive engagement allows for easier steering when maneuvering the vehicle.

ROCK SMART MODE MODULE

Maverick X3, Maverick X3 MAX
715005283
\$154.99

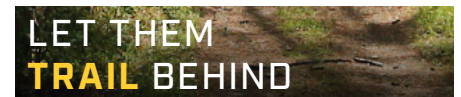

- Designed for aggressive riding delivering the ultimate cornering precision.
- When high engine torque and/or an increase in vehicle speed is detected, Smart-Lok™ will progressively engage the front end and maintain it engaged until throttle release or vehicle speed reduction.
- The progressive engagement allows for lower smooth steering effort.

TRAIL ACTIV SMART MODE MODULE

Maverick X3, Maverick X3 MAX
715005284
\$154.99



FIRE EXTINGUISHER

- Ideal for grease, oil and electrical fires.
- Fits with Lonestar Racing Fire Extinguisher Support Kit.
- Not EC compliant.

295100833 
\$29.99



LONESTAR RACING QUICK RELEASE CLUTCH COVER PINS

- This kit will allow you to take off your clutch cover in seconds to access the belt tool-lessly.
- Includes 4 stainless steel "quick release" pins with clips and tethers.
- Replaces all clutch cover screws.
- This product affects the clutch cover sealing. It is highly recommended to use this product under dry riding conditions only.

Maverick X3, Maverick X3 MAX
 715005045 
\$99.99

LONESTAR RACING HEAVY-DUTY REAR BOXED RADIUS ROD SUPPORT PLATE

- Double-layered radius rod support plate made of high-grade steel.
- Reinforces your rod mounting location on the frame while adding a mean racing look to your vehicle.
- Easy to install.

Maverick X3, Maverick X3 MAX
 715005046 
\$204.99

LONESTAR RACING FIRE EXTINGUISHER SUPPORT

- Quick-release support that allows you to slide the fire extinguisher out in a matter of seconds in an emergency situation.
- Made of billet anodized black aluminum.
- Provides you with the safety and security of having dependable emergency equipment on board.
- Fits 1.85" (4.7 cm) tubing.
- Can be fixed everywhere on the cage.
- Comes with both billet mounts, quick-pull pin, mounting plate and 2 clamps.
- Fire extinguisher sold separately.
- "Lonestar Racing for Can-Am" branded.

Maverick X3, Maverick X3 MAX
 715003734 
\$184.99

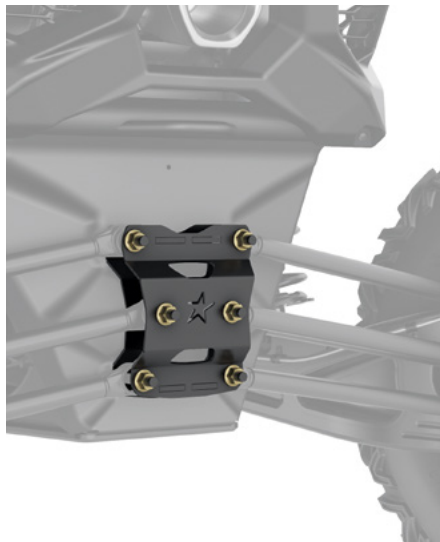



EXPERT CHOICE

YOSHIMURA SLIP-ON EXHAUST

- Developed in collaboration with Yoshimura.
- Made from 304-grade stainless steel with brushed aluminum tip.
- Better sounding, better looking and 19% lighter than stock muffler.
- USDF/USDA approved spark arrester.
- Fuel injection system tuning not required.
- ROHVA and EPA compliant.
- Not EC compliant.

Maverick X3, Maverick X3 MAX

715005183 · In-Line Triple 
\$1,289.99

715002882 
\$1,054.99

INSTALLATION 



715005183

715002882

X rc BRAKE PEDAL

- Brake pedal with larger foot surface.
- This improves ergonomics and control for the rider in rock climbing conditions.

Maverick X3, Maverick X3 MAX

715004901

\$50.99





HIGH OUTPUT 172HP UPGRADE KIT X3

- Performance upgrade kit for Maverick X3 2017 models only.
- Gain 18 HP for a total of 172 HP.
- Includes: Intercooler with fan, fuel pump catalyst and high performance belt.
- Installation must be done by an authorized BRP dealership to preserve the vehicle's warranty.
- C.A.R.B. Executive Order #D-799U.

Maverick X3, Maverick X3 MAX (2017 models)

715004700 **\$1,444.99**

NEW 172HP INTERCOOLER UPGRADE KIT

- Intercooler upgrade for the Maverick X3 2018 and up
- Installation must be done by an authorized BRP dealership to preserve the vehicle's warranty.
- Requires the power upgrade installation kit (715007111).

Maverick X3, Maverick X3 MAX (2018 and 2019)

715007137 **\$799.99**

Maverick X3, Maverick X3 MAX (2020 & up)

715007277 **\$799.99**

NEW 850W MAGNETO KIT

- Increases the magneto output to 850W.
- Includes rotor, stator and regulator.

Maverick X3, Maverick X3 MAX 2018 & up (except 90 hp engine)

715006279 **\$649.99**



NEW POWER UPGRADE INSTALLATION KIT

- Increases the power of the Maverick X3 from 120 hp to 172 hp.
- Includes fuel pump, clutch components and turbo adjustment.
- Installation must be done by an authorized BRP dealership to preserve the vehicle's warranty.
- Requires Maverick X3 intercooler specific to model year (715007137 or 715007277).

Maverick X3, Maverick X3 MAX

715007111 **\$799.99**



ARCHED LOWER SUSPENSION LINKS

- Arched lower links to free up more ground clearance.
- Standard on X mr and X rc models.

Maverick X3, Maverick X3 MAX

715005066 • 72" models **\$204.99**

715005065 • 64" models **\$194.99**

*WARNING: Any modifications or addition of accessories may affect the handling of your vehicle. It is important to take the time to get familiar with the vehicle once modifications are made to understand how to adapt your driving behavior accordingly. Do not tamper with unauthorized modifications or install equipment not specifically certified by BRP for the vehicle. These modifications have not been tested by BRP and they may increase the risk of injury or loss of control, or render the vehicle illegal to ride. Ask your authorized BRP dealer for suitable available accessories for your vehicle.



RADIATOR RELOCATOR

- Relocates stock radiator to rear of cage.
- Protects it from debris and rocks.
- Prevents cooling performance loss in muddy condition.
- Reduces hot air in the cabin.
- Easy to clean.
- Includes support hardware and hoses.
- Not compatible with any bed accessories, Rear Cage mounted accessories, Complete MTX Audio system and Upper Soft Doors (except LinQ 8 Gal [30 L] Cooler Box).
- Radiator (709200703) is required for installation on 2017 models.

Maverick X3, Maverick X3 MAX

715004937

\$1,159.99 

SNORKEL PRE-FILTER

- Pre-filter specifically for snorkels.
- Adds extra protection to your engine in harsh riding conditions.
- Helps keep air filter cleaner.
- Filter blocks particles larger than 0.005" (0.13 mm).
- Necessary to maintain vehicle warranty when tracks are installed.

Maverick X3, Maverick X3 MAX
(with Snorkel kit)

715005599

\$99.99



SNORKEL KIT

- Raises point of engine and CVT air intakes so vehicle can be semi-submersed in water or mud without the engine taking in water.
- Not compatible with S&B Particle Separator, LinQ Pivoting Rack, Lonestar Racing Rear Intrusion Bar or any rear panels or windows.
- Sealed Air Box 707800780 (sold separately) is required for installation on models manufactured before January 1, 2018.
- Standard on Maverick X3 X mr models.
- Not EC-compliant.

Maverick X3, Maverick X3 MAX
(2019 and prior)

715003733

\$724.99

Maverick X3, Maverick X3 MAX
(2020 & up)

715007110

\$759.99



EMERGENCY KIT

- Complete emergency kit provides all essential equipment and supplies to get out of most unfavorable situations powersport enthusiasts may find themselves in.
- Includes jumper cables, air compressor, tire-repair kit, first-aid kit, ratchet tie-down, duct tape, 3,300 lb (1,500 kg) tow strap, zip-ties and cloth rags.

Maverick X3, Maverick X3 MAX

715006102

\$129.99



PERFORMANCE TWIN AIR FILTER

- The best choice for the harshest conditions.
- Multiple staged oiled filtering foam for superior dust retaining capacity with high air flow.
- Washable and reusable.

Maverick X3, Maverick X3 MAX

715002895

\$104.99



FOAM REPLACEMENT

(Not illustrated)

- Replacement foam for Performance Twin Air Filter.

Maverick X3, Maverick X3 MAX

707800713

\$40.99

COVERS & ADD-ONS



TRAILERING COVER

(Not illustrated)

- Heavy-duty canvas made of UV-resistant solution-dyed polyester.
- Inner soft liner protects windshield and colored panels from abrasion.
- All high-abrasion areas are reinforced with a double canvas layer.
- Weather-resistant trailering cover protects your vehicle during storage and transportation.
- Opening for fuel cap and cabin access on passenger side.
- Quick and easy installation.
- Designed to perfectly fit your vehicle with or without Can-Am accessories.

Maverick X3

715005813

\$344.99

Maverick X3 MAX

715005814

\$434.99

RATCHET TIE-DOWNS

- 400 lb (181 kg) safe working load.
- 1" x 10' (2.5 cm x 3 m) strap with Sea-Doo, Ski-Doo and Can-Am logos.
- Deluxe ratchet with rubber handle.
- Coated S hooks.
- Pack of 2.

860200447 • Black/Grey

\$17.99



BOLT-ON[†] RETRACTABLE RATCHETING TIE-DOWNS

- Perfect for transporting your powersport vehicle or securing loads.
- Mounts easily: Bolts on any flat surface (e.g., truck bed or frame).
- 1" x 6' (2.5 cm x 1.8 m) tie-down strap with heavy-duty stitching that delivers a 500 lb (226 kg) working load strength and 1,500 lb (680 kg) break strength.
- Convenient retractable push button automatically slackens, spools and stores away strap, while the ratchet mechanism tightens the strap snugly to secure your vehicle or load into place.
- Rubber ratcheting handle provides firm grip, and the hook is vinyl coated to protect whatever surface it hooks into.
- Sold in pairs.

295100737

\$30.99



NEW RATCHET STRAP KIT

- 1,000 lb (454 kg) safe working load.
- 1.5" x 6' (38 mm x 1.8 m) strap with BRP brands.
- Deluxe ratchet with rubber handle.
- Black-coated clip hooks.
- Two 18" (460 mm) assists straps included.
- Pack of two.

715006227

\$39.99



APACHE TRACK SYSTEMS



EACH TRACK HAS A SPECIFIC PURPOSE AND IS DESIGNED WITHOUT COMPROMISE FOR WORK AND PLAY. WHETHER IT'S FOR DEEP SNOW RIDING, TRAIL RIDING OR FOR HEAVY LOADS, APACHE TRACKS ARE AKIN TO FLOATING ACROSS THE TERRAIN.



WINTER TRACKS

APACHE BACKCOUNTRY

Finally explore winter with no traction limitations and no compromise, thanks to the unmatched performance of Apache Backcountry track kits. Engineered to thrive in the deepest snow—for work or play. Don't let winter stand in the way.



YEAR-ROUND TRACKS

APACHE 360, 360 LT

Adapt your track setup to the conditions you'll be riding in and the purpose of your ride with the Apache 360 LT system: our all-season, all-terrain masterpiece.

WINTER TRACKS

GET THE MOST OUT OF YOUR CAN-AM VEHICLE THIS WINTER FOR ALL YOUR ENDEAVORS.

The same technology behind our world-renowned snowmobiles is at your command. With a larger contact patch, and more aggressive track design, travel beyond what you thought possible with the best snow performance.



COVERED BY A
1-YEAR WARRANTY

APACHE BACKCOUNTRY

Efficient frame and rail design ensures weight is evenly distributed

Added ground clearance of 6.4" (16.2 cm)

Aggressive track design with a 2" (5 cm) lug height for maximum traction

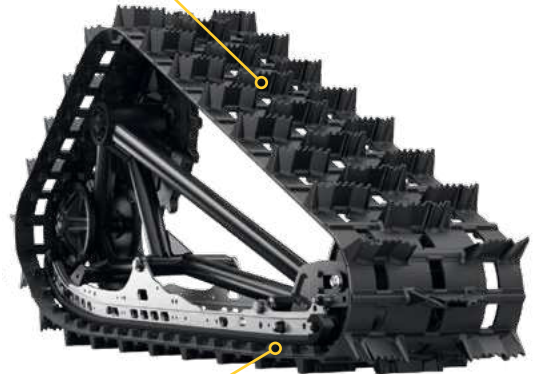
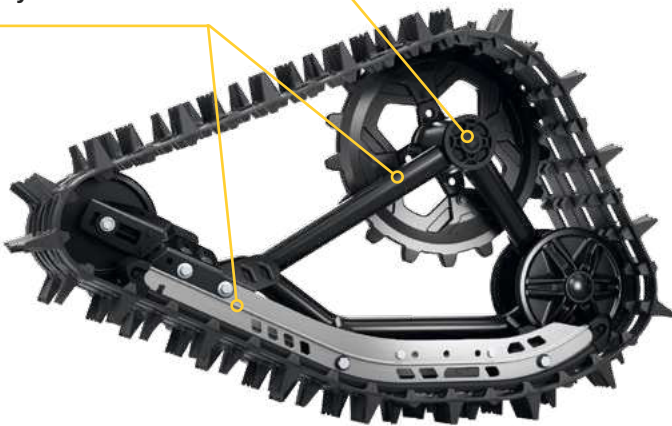

Largest contact patch anywhere: 37% more than the Apache 360 LT

APACHE BACKCOUNTRY LT TRACK SYSTEM

- Tracks designed to deliver the best snow performance on the market with unmatched flotation level and traction on snow surface.
- Large contact patch, 37% bigger than the Apache 360 LT.
- Impressive added ground clearance of 6.4" (16 cm) helps keep the vehicle over the snow.
- Lightweight snowmobile-inspired rail design.
- Aggressive track design with 2" (5 cm) lug height for maximum traction on snow.
- Apache Backcountry LT Mounting Kit, Track DPS Module and Engine and CVT Pre-Filter are required.
- Fine-tune your track system using extra Idler Wheels, Sliders with Vespel Inserts and Rail Ice Scratcher.
- For winter use only.

Maverick X3, Maverick X3 MAX

715004734

\$6,249.99



NEW RAIL ICE SCRATCHERS

- Provide additional lubrication in hard and icy conditions.
- Rail mounted, small, light.
- Design expands on coil concept to allow reversing without damage.
- Easily stored when not in use.

Apache Backcountry Track System

860201728

\$94.99



SLIDERS WITH VESPEL[†] INSERTS

- Use DuPont Vespel inserts for less friction.
- Longer life.
- Can be cut to desired length.
- 8 needed per vehicle.
- Sold individually.

Apache Backcountry and Apache Backcountry LT Track System

503194815

\$89.99



APACHE BACKCOUNTRY LT MOUNTING KIT

(Not illustrated)

- Required for installation of the Apache Backcountry Track LT System.
- DPS module and Pre-Filter are required and sold separately.

Maverick X3, Maverick X3 MAX

64" models

715004397

\$749.99



72" models

715004394

\$849.99



NEW EXTRA WHEEL KIT

- Additional wheel kit for Backcountry LT rear tracks.
- Reduces drag and rolling resistance in hard snow conditions or when transporting heavier loads.
- Extends slider life in hard snow conditions.
- Includes two wheels, cross shaft and mounting hardware per kit to service one track corner.
- Up to two kits per rear track can be installed.

Apache Backcountry LT Wheel Kit

715006293

\$99.99

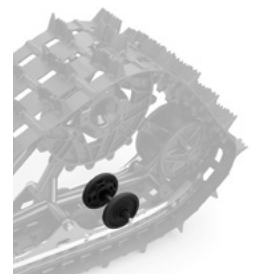



COVERED BY A
**2-YEAR
WARRANTY**

YEAR ROUND TRACKS

WORK & PLAY YEAR ROUND THROUGH MUD, SNOW & ALL TYPES OF TERRAIN.

Rise above terrain and weather, with the Apache 360 LT track kits — the upgrade that takes the Can-Am experience to another level. Designed for superior traction and carrying heavier loads in soft terrain, 360LT track kits can be installed on ATV and SSV vehicles and used for exploring and completing tough tasks.

APACHE 360 LT

Added ground clearance of 4.5" (11.4 cm)

Quick & easy installation

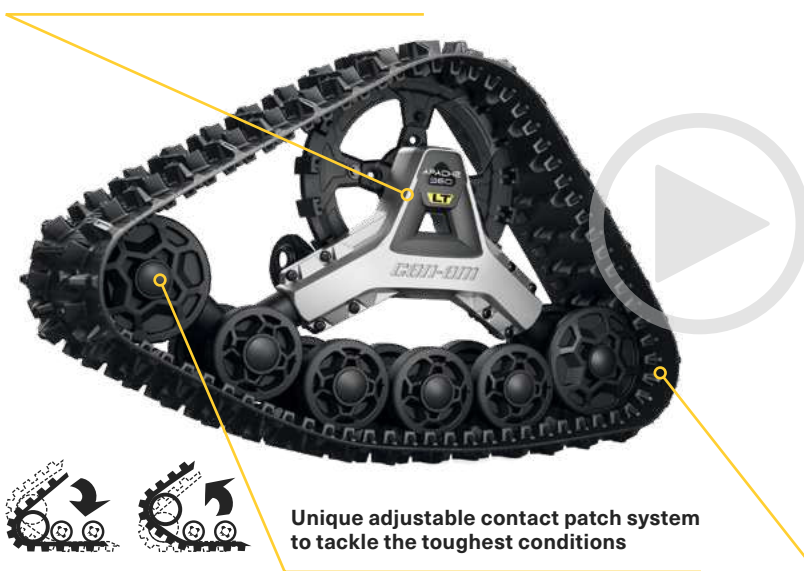

Unique adjustable contact patch system to tackle the toughest conditions



Total ground surface area of 2,079.7 in² (13,417 cm²)

Rubber over molded heavy-duty double bearing wheels and offset wheel spacing reduce friction and vibration while ensuring reliability

APACHE 360 LT TRACK SYSTEM

- Multifunctional tracks designed to support heavy loads and to fit on most Can-Am Off-Road vehicles.
- Front wheel height adjustment provides enhanced attack angle and better performance over rough terrain when raised or increased contact patch for improved flotation when lowered.
- Average ground clearance increase of 4.5" (11.4 cm).
- 1" (2.5 cm) lugs in the front and 1.25" (3.2 cm) in the back.
- Apache 360 LT Mounting Kit, Track DPS Module and Engine and CVT Pre-Filter Kit are required.
- Reliable heavy-duty build.
- EC compliant.
- Recommended for use on snow only for Maverick X3.

Maverick X3, Maverick X3 MAX

715005103
\$4,699.99

APACHE 360 LT MOUNTING KIT

- (Not illustrated)
- Required for installation of the Apache 360 LT Track System.
 - Track DPS Module and Pre-Filter not included.

Maverick X3, Maverick X3 MAX

64" models
715004392
\$674.99

72" models
715004393
\$874.99

TRACK DPS MODULE

- (Not illustrated)
- Innovative DPS module that ensures speedometer accuracy and optimized steering assist, making for perfect track control and riding ease.
 - Required to install the Apache Track Systems.

Maverick X3, Maverick X3 MAX

715006266
\$124.99

Required to install the Apache Backcountry and Apache 360 LT Track Systems

ENGINE & CVT AIR INTAKE PRE-FILTER

- Adds extra protection to your engine in harsh riding conditions.
- Helps keep air filter cleaner.
- Filter blocks particles larger than 0.007" (0.19 mm).
- Easy installation.
- Not compatible with S&B Particle Separator.
- Necessary to maintain vehicle warranty when tracks are installed.

Maverick X3, Maverick X3 MAX (except X mr models)

715005600
\$99.99



SNORKEL PRE-FILTER

- Pre-filter specifically for snorkels.
- Adds extra protection to your engine in harsh riding conditions.
- Helps keep air filter cleaner.
- Filter blocks particles larger than 0.005" (0.13 mm).
- Necessary to maintain vehicle warranty when tracks are installed.

Maverick X3, Maverick X3 MAX (with Snorkel kit)

715005599
\$99.99



PROMOUNT PLOWS

THE PROMOUNT LINEUP WAS CREATED FOR BOTH PROFESSIONAL OPERATORS AND ENTHUSIASTS LOOKING TO TAKE THEIR TOOL KIT TO THE NEXT LEVEL. DESIGNED TO WORK AS EFFICIENTLY AS POSSIBLE, CAN-AM REIMAGINED THE PLOW FROM MOUNT TO BLADE.



MOST EFFICIENT MOUNTING SYSTEM

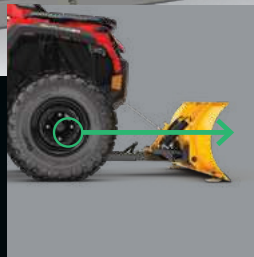

Underbelly mounting plate provides the optimal angle of attack for best push strength.

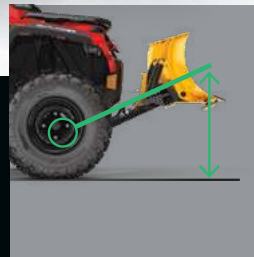

The forward mounted push frame provides industry leading lift height.



Low profile mounting plate has little impact on ground clearance and can be left installed year round.

CONNECTS WITH A CLICK

Attachable in **FOUR EASY STEPS**, the Can-Am ProMount plow system is the fastest, easiest way to start plowing and get the job done—minimal effort for maximum result.

1



Drive straight toward the plow.

2



Attach the winch cable to the plow using a guiding hook/roller.

3



Lift the plow until it clips onto the mounting plate.

4



Remove the winch cable from the guide. You're ready to plow.

CAN-AM PROMOUNT ANGLE PLOWS

NEW CAN-AM ANGLE BLADES

- Make the job easier with the right tools, clear long alleys and make the task easier by sending the snow further out of the way.
- Wing end of plow measures 25" (63 cm) high and tapers down to 16" (41 cm).
- One-way "winged" state plow designed to throw snow higher.
- Rubber flap designed to keep snow away from the driver.
- Can-Am branded.

72" [183 CM] STEEL ONEWAY STATE BLADE

■ 715007264 · Black
\$439.99



YOUR JOB, YOUR CHOICE

Get a custom solution that truly fits the task at hand—with quality components and no cut corners. The ProMount mounting plate, push frame, and blades are a universal system that can be adapted to your specific Can-Am and jobsite.

CAN-AM PROMOUNT PUSH FRAME WITH QUICK-ATTACH SYSTEM

- Heavy-duty steel tubes designed to withstand the roughest use.
- Mid-mount carriage provides ultimate push strength and traction.
- Designed for maximum plow lift height.
- Features a self-aligning quick-attach system, an easy foot release pedal and an ergonomic handle for plow angle adjustment.
- Plow Roller Fairlead and Plow Limit Switch recommended to extend winch cable lifespan.
- Can-Am ProMount Mounting Plate required for installation.
- Blade swivels left or right, 5 positions.
- Large pin designed for easy blade rotation to eliminate dirt and snow buildup at pivot point.

Maverick X3, Maverick X3 MAX

715003910
\$494.99



CAN-AM PROMOUNT MOUNTING PLATE

- Required to install the Can-Am ProMount Push Frame with Quick-Attach System.
- Mounting plate precision-designed to stay on year round without compromising ground clearance.
- Not compatible with S3 Front High Clearance A-Arm (715003784 and 715005116).

Maverick X3, Maverick X3 MAX

715007744
\$134.99



PUSH FRAME EXTENSION

- 12" (30 cm) push frame extension required when plow is installed with Apache Track Systems.

Maverick X3, Maverick X3 MAX

715006257
\$149.99

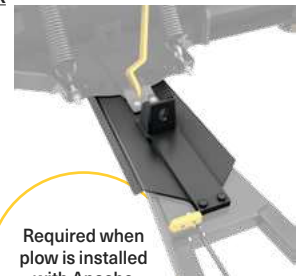

CONSULT YOUR DEALER FOR THE BEST PLOW WIDTH.

Made from 12-gauge steel and designed for efficient plowing, the ProMount steel blades are offered in multiple sizes to fit jobs large or small.

CREATE YOUR OWN KIT

by choosing any plow type/length that you'd like for your push frame. **ProMount Push Frames are compatible with all the blades.**

CAN-AM PROMOUNT FLEX2 PLOWS

HMWPE (High Molecular Weight Polyethylene) technology gives Flex2 greater reliability, resistance to impact, and immunity to rust or deformation. Tough on jobs but flexible in the face of obstacles, the Flex2 blade simplifies work.

CAN-AM PROMOUNT FLEX2 PLOW KIT

These kits include:

- Can-Am ProMount Flex2 Blade
- Push Frame with Quick-Attach System
- Can-Am ProMount Mounting Plate

72" (183 CM) BLADE

Maverick X3, Maverick X3 MAX

715007772 • Black

\$1,134.97



CAN-AM PROMOUNT FLEX2 BLADES

- Blades available individually to create your own kit.
- Compatible with Can-Am ProMount Blade accessories to further enhance plow versatility.

72" (183 CM) BLADE

- Clears 66" (168 cm) when plow is fully angled.

ProMount Push Frame

715004485 • Black

\$504.99



72" (183 CM)

CONSULT YOUR DEALER FOR THE BEST PLOW WIDTH. Made from 12-gauge steel and designed for efficient plowing, the ProMount steel blades are offered in multiple sizes to fit jobs large or small.

CREATE YOUR OWN KIT

by choosing any plow type/length that you'd like for your push frame. **ProMont Push Frames are compatible with all the blades.**

CAN-AM PROMOUNT STEEL PLOWS



Made from 12-gauge steel and designed for efficient plowing, the ProMount steel blades are offered in multiple sizes.

CAN-AM PROMOUNT STEEL PLOW KITS

These kits include:

- Can-Am ProMount Steel Blade
- Push Frame with Quick-Attach System
- Can-Am ProMount Mounting Plate

Maverick X3, Maverick X3 MAX

- 715007773 · Black 
- 715007906 · Yellow 

\$1,024.97



CAN-AM PROMOUNT STEEL BLADES

- Blades available individually to create your own kit.
- Compatible with Can-Am ProMount Blade accessories to further enhance plow versatility.

72" (183 CM) BLADE

- Clears 66" (168 cm) when plow is fully angled.
- Blade height of 17" (43 cm).

ProMount Push Frame

- 715004474 · Black
- 715006021 · Yellow

\$394.99



CONSULT YOUR DEALER FOR THE BEST PLOW WIDTH.

Made from 12-gauge steel and designed for efficient plowing, the ProMount steel blades are offered in multiple sizes to fit jobs large or small.

CREATE YOUR OWN KIT

by choosing any plow type/length that you'd like for your push frame. **ProMount Push Frames are compatible with all the blades.**

CAN-AM PROMOUNT PLOW ACCESSORIES

1 CAN-AM PROMOUNT EDGE MARKERS

- Help locate the edges of your plow.
- Height: 24" (60 cm).
- Sold in pairs.
- Compatible with Can-Am ProMount Steel and Flex2 Blades with or without Blade Extensions (except for the Can-Am ProMount Steel 54" (137 cm) Blades).

Maverick X3, Maverick X3 MAX

715004206

\$39.99



2 CAN-AM PROMOUNT PLASTIC WEAR BLADE*

- To help prevent scratches on smooth driveways and markable surfaces.

Maverick X3, Maverick X3 MAX

66" (168 cm) 72" (183 cm)

715004482

\$79.99



715004483

\$134.99



3 CAN-AM PROMOUNT DRIFT CUTTERS*

- Help keep snow in the plow.
- Dimensions: 17" x 13" (43.2 cm x 33 cm).
- Sold in pairs.
- Compatible with Can-Am ProMount Steel and Flex2 Blades with or without Blade Extensions (except for the Can-Am ProMount Steel 54" [137 cm] Blades).

Maverick X3, Maverick X3 MAX

715006258

\$134.99



4 CAN-AM PROMOUNT BLADE EXTENSIONS

- Add 3" (8 cm) each side.
- Compatible with Can-Am ProMount Blades (except for Can-Am ProMount Steel 54" [137 cm] Blade).
- Longer Wear Blade can be installed to further extend the extra length already provided by the extensions.
- Compatible with Can-Am ProMount Steel and Flex2 Blades (except for the Can-Am ProMount Steel 54" [137 cm] Blades).

Maverick X3, Maverick X3 MAX

715004205 • Black

715005319 • Yellow

\$99.99



PLOW ANGLING SYSTEM

- Converts your plow system into an easy-to-control unit from the driver's seat.
- Allows you to have full up/down and left/right plow control at your fingertips by using the supplied joystick.
- Using one hand to control all plow motions will allow you to easily concentrate and manage your plowing tasks.
- Not compatible with Backcountry LT track kits on Maverick X3.

Compatible with any ProMount Push Frame and Blade

715006022

\$979.99



PLOW ROLLER FAIRLEAD

- Larger diameter lower roller reduces wear on wire rope for plow application.
- Can be used with all ProMount plows.

Maverick X3, Maverick X3 MAX

705203753

\$74.99



PLOW LIMIT SWITCH

(Not illustrated)

- For controlling the cable tension when over raising your plow system.
- Prevents winch, plow push frame and vehicle damage.
- Sensor relocated for optimal lift height.

Maverick X3, Maverick X3 MAX

715006259

\$114.99



TIRES & RIMS

TIRES

X ds TIRE MAXXIS BIGHORN

(Not illustrated)
Front – 29" x 9" x 14"
705402081
\$194.99

Rear – 29" x 11" x 14"
705502604
\$204.99

X rs TIRE MAXXIS BIGHORN

(Not illustrated)
Front & Rear – 30" x 10" x 14"
705402082 
\$220.99

MAXXIS BIGHORN 2.0 TIRE

Front – 28" x 9" x 14"
705402080 
\$178.99

Rear – 28" x 11" x 14"
705502603
\$173.99

Front – 27" x 9" x 14"
705402168 
\$168.99



Rear – 27" x 11" x 14"
705502665 
\$168.99





MAXXIS LIBERTY TIRE

- Engineered for performance driving and to give you and your side-by-side freedom in a variety of terrains.
- 8-ply radial construction.

Maverick X3 Xrc
30" x 10" x 14"
705402143
\$209.99

32" x 10" x 15"
705402464
\$230.99



RIMS

14" MAVERICK X3 X mr RIM

- Black with clear coat aluminum rim.

Maverick X3, Maverick X3 MAX
705402256
\$204.99



14" MAVERICK X3 BEADLOCK RIM

- Black aluminum rim with machined face and clear coat.
- Choice of beadlock color (not included).
- Needs 16 bolts (250000893) for installing the beadlock.

Maverick X3, Maverick X3 MAX
 705402207 • Black and machined 
 705402173 • Black
 \$204.99



14" MAVERICK X3 BEADLOCK RIM

- Black with clear coat aluminum rim.
- Choice of beadlock color.
- Needs 16 bolts (250000893) for installing the beadlock.

Maverick X3, Maverick X3 MAX
Front – 14" x 7"
• Offset = 55 mm
• For Xrs = Front and rear
705402393
\$189.99

Rear – 14" x 8"
• Offset = 76mm
705502814
\$199.99



14" MAVERICK X3 BEADLOCK RING

- Cast aluminum beadlock.
- Must be installed on Front Rim (705402393) and Rear Rim (705502814).

Maverick X3 & Maverick X3 MAX
(X rs, X ds models only)
 705401709 • Black 
 705401913 • Gold
 705402358 • Can-Am Red
 705402472 • Manta Green
 \$78.99



14" MAVERICK X3 RIM

- Black with clear coat aluminum rim.

Maverick X3 & Maverick X3 MAX
Front – 14" x 7"
• Offset = 55 mm
705401965 
\$107.99

Rear – 14" x 8"
• Offset = 76 mm
705502493
\$107.99



APPAREL

Clothing, helmets, glasses and everything else you need to shift your Can-Am experience into high gear.

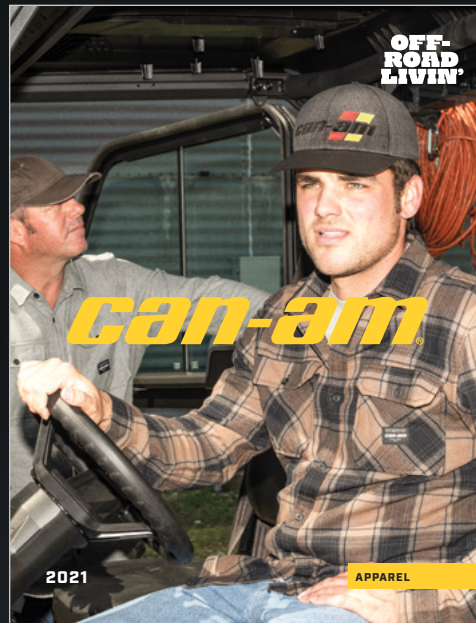

PARTS & MAINTENANCE

Essential items to keep your Can-Am tearing up the tarmac, including oils, filters maintenance products and cleaning products.

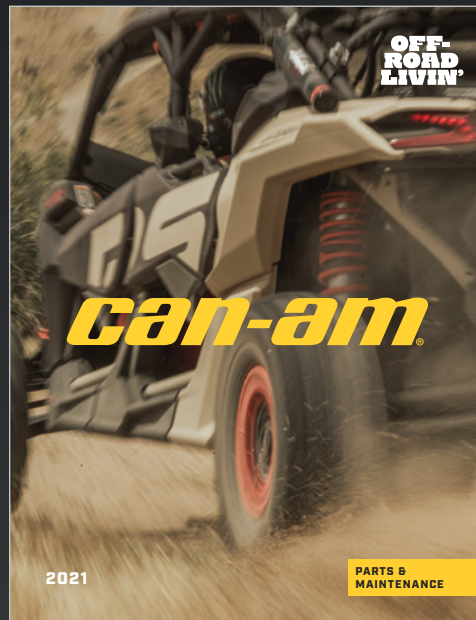

EXPLORE AN ENTIRE WORLD OF ADVENTURE WITH ALL OF OUR BRP PRODUCTS. BRP.COM



ski-doo LYNX SEA-DOO CAN-AM ROTAX ALUMAcraft Manitou Evinrude



CAN-AMOFFROAD.COM

